

JOURNAL

of the

AMERICAN VIOLA SOCIETY

Section of
THE INTERNATIONAL VIOLA SOCIETY
Association for the Promotion of Viola Performance and Research

Vol. 13 No. 1

1997



VIOLIST oder BRATSCHIST.

Die Stim ist etwas rauh, so die Virole giebet.
Doch heist sie angenehm, dem der sie recht versteht.
ein Stück wird edeler geachtet und geliebet.
wann dieser artige Thon zugleich darunter geht.
Rom, so die Mutter-Stadt der Music-Künstler heißet,
ist, die mein Instrument als etwas schönes preißet.



FEATURES

- 13 Fifty Years in the Hot Seat:
An Interview with Joseph de Pasquale
- 27 Bow Strokes for a Rich Sound
By Pamela Ryan
- 33 Beyond Brahms: Twentieth-Century
Repertoire for Alto (Mezzo) with Viola
By Sheila M. Allen
- 49 New Acquisitions in PIVA

American Viola Society

OFFICERS

Thomas Tatton
President
2705 Rutledge Way
Stockton, CA 95207
(209) 952-9367

Pamela Goldsmith
Vice-President
11640 Amanda Drive
Studio City, CA 91604

Donna Lively Clark
Secretary
JCFA, Butler University
4600 Sunset
Indianapolis, IN 46208

Mary I. Arlin
Treasurer
School of Music
Ithaca College
Ithaca, NY 14850

Alan de Veritch
Past President
School of Music
Indiana University
Bloomington, IN 47405

BOARD

Atar Arad
Victoria Chiang
Ralph Fielding
John Graham
Lisa Hirschmugl
Jerzy Kosmala
Jeffery Irvine
Patricia McCarty
Paul Neubauer
Karen Ritscher
Christine Rutledge
Pamela Ryan
William Schoen

EDITOR, JAVS

David Dalton
Brigham Young University
Provo, UT 84602

PAST PRESIDENTS

Myron Rosenblum (1971–81)
Maurice W. Riley (1981–86)
David Dalton (1986–1991)

HONORARY PRESIDENT

William Primrose (deceased)



The *Journal of the American Viola Society* is a peer-reviewed publication of that organization and is produced at Brigham Young University, © 1985, ISSN 0898-5987. *JAVS* welcomes letters and articles from its readers.

Editorial Office:
School of Music
Harris Fine Arts Center
Brigham Young University
Provo, UT 84602
(801) 378-4953
Fax: (801) 378-5973
david_dalton@byu.edu

Editor: David Dalton
Associate Editor: David Day
Assistant Editor for Viola Pedagogy: Jeffrey Irvine
Assistant Editor for Interviews: Thomas Tatton
Production: Kristen Gough & Marcus Smith
Advertising: Jeanette Anderson

Advertising Office:
Crandall House West (CRWH)
Brigham Young University
Provo, UT 84602
(801) 378-4455
linda_adams@byu.edu

JAVS appears three times yearly. Deadlines for copy and artwork are March 1, July 1, and November 1; submissions should be sent to the editorial office.

Ad rates: \$100 full page, \$65 half page, \$35 one-fourth page.
Classifieds: \$25 for 30 words including address; \$40 for 31–60 words.
Advertisers will be billed after the ad has appeared.
Payment to the American Viola Society should be remitted to the advertising office.

Our Silver Anniversary Congress



Thomas Tatton

An outstanding five days has been planned for you at our forthcoming Silver Anniversary Congress. World-class artists, clinicians, and scholars will meet this June in Austin to perform, teach, and lecture, making this the most exciting congress yet. There will be exhibits of new music and quality instruments for you to inspect and play. And don't forget to bring your own instrument as there will be ample opportunity for you to participate.

You have my guarantee that you will most certainly find this congress musically, educationally, and socially rewarding.

Special thanks to our host chairman, Professor Roger Myers, and to Dr. Ronald Crutcher, Director of the School of Music, for the planning, coordination, and administration of this congress. And, of course, our thanks to you—your participation in the congress and in our society is vital for the continued strength of our organization.

Please accept my personal invitation to attend the 25th International Viola Congress. I look forward to seeing you this June in Austin.

—Thomas Tatton, President, American Viola Society



Roger Myers, Host Chairman

Performances, Lectures, and Master Classes by

Heidi Castleman
Victoria Chiang
Jonathan Craig
Karen Elaine
Csaba Erdelyi
Igor Fedotov

Barbara Hamilton
Tom Heimberg
David Holland
Ronald Houston
Jeff Irvine
Scott Lee

Victoria Miskolczy
Paul Neubauer
Jutta Puchhammer
Lynn Ramsey
Karen Pitscher
Eufrasina Raileanu

Matthew Rombaum
Pamela Ryan
Sabina Thatcher
Karen Tuttle
Geraldine Walther
Bernard Zaslav

We will be joined, for a fascinating examination of the Bartók Viola Concerto, by internationally acclaimed Bartók scholars: Elliot Antokoletz, Malcolm Gillies, and Donald Maurice.

Special Appearances:

Norwegian virtuoso Lars Anders Tomter
Joseph de Pasquale, Congress Dedicattee

Kathy Basrak, Winner, 1995 Primrose Memorial Scholarship Competition

1997 PRIMROSE MEMORIAL SCHOLARSHIP COMPETITION
America's most prestigious competition exclusively for violists

Sponsored by THE AMERICAN VIOLA SOCIETY

First prize: \$2000

Second prize: \$1000

Third prize: \$500



XXVth International Viola Congress
The University of Texas at Austin
School of Music
June 3–7, 1997

The School of Music is located in the midst of the active and stimulating cultural environment of Austin, Texas. The atmosphere of a major institution of learning, with approximately 50,000 students and more than 70 academic departments and programs of study, combines with the more intimate feel of a friendly School of Music that enjoys an enrollment of approximately 350 undergraduate students.

The School of Music is housed in the superbly equipped six-story Music Building and Recital Hall and is an integral part of the Performing Arts Center. These performance and workshop areas are among the most technically advanced and best equipped in the world, and include 3000 seat Bass Concert Hall (home of the Austin Symphony Orchestra, Austin Lyric Opera, and Ballet Austin), the 400 seat McCullough Theater, the acoustically outstanding 325 seat Jessen Auditorium, and Bates Recital Hall, a 700 seat auditorium that houses the monumental four-manual, 67-stop Visser-Rowland tracker organ.

The School of Music presents more than 400 public recitals and concerts annually and brings a number of prominent guest lecturers and artists to campus each semester. Recent participants have included Dorothy DeLay, Itzhak Perlman, Pinchas Zuckerman, Donald McInnes, Isaac Stern, double bass virtuoso François Rabbath, the Tokyo String Quartet, Lukas Foss, fortepianist Malcolm Bilson, Mozart specialists Paul and Eva Badura-Skoda, and composers Michael Colgrass, John Corigliano, Karen Husa, Thea Musgrave, and Gunther Schuller.

Off-Campus Housing

The official hotels for the Congress are the Omni Downtown and the Holiday Inn Town Lake. The Omni is offering a special discounted rate of \$85 per night; the Holiday Inn will offer a special rate of \$84 per night. Please contact the hotels directly (Omni: 512-476-3700; Holiday Inn: 512-472-8211). To reserve rooms at these special rates, please identify yourself as an attendee of the 25th International Viola Congress and do so no later than May 1. Other hotels and motels are in close proximity to the UT School of Music. Please contact the Austin Convention and Visitors Bureau at 1-800-926-2282.

Meals

A variety of interesting food options are available within walking distance from the UT campus and the School of Music. Specific information on these will be provided in the welcome packets. Additionally, meals can be purchased on a per-meal basis at both residence halls.

Airfare

World Wide Travel of Austin will offer a discount on all domestic and international flights. Additionally, if you contact the agency as soon as possible but do not yet wish to make reservations, you can arrange to be notified directly of low fares. Please call 1-800-838-3886, or email: <dsovine@wwts.com>, <sbaird@wwts.com>, or <akattan@wwts.com>.

Payment Information

We can accept payment for registration, University housing, and the banquet only. Those staying in hotels may pay these establishments directly. Please remember that AVS membership may be sent to us, but should be paid separately (payable to The American Viola Society).

Checks should be made out to *UT Austin*. We regret that we cannot accept credit cards. You may send your registration by mail, fax, email, or via our website. Payment must be postmarked by May 15 for early registration. If your registration form is received before this date but your payment is not, a late fee will be assessed.

Please mail your form to:

The University of Texas at Austin
School of Music
Austin, TX 78712
attn: 25th International Viola Congress

Phone: 512-232-2383
Fax: 512-471-6449
email: viola@mail.music.utexas.edu
web site: <http://www.utexas.edu/cofa/music/violacon>

Please use one form per registrant. Xerox copies of this form will be accepted.

RETURN BY MAY 15, 1997

Name _____
Mailing Address _____
City _____ State _____ Zip _____
Day telephone () _____ Evening telephone () _____
Email address _____
Name as you wish it to appear on your badge (first/last) _____
Institutional affiliation to appear on badge _____

Membership

I am currently a member of:

- American Viola Society (AVS)
 Canadian Viola Society (CVS)
 International Viola Society (IVS)
 I wish to register for this Congress as a member of AVS. I am enclosing a separate check payable to the American Viola Society (\$30 Adult/Professional; \$15 Student; \$35 Non-US Resident).

Full Registration

	Postmarked by May 15	After May 15 or on-site
<input type="checkbox"/> AVS-CVS-IVS Adult/Professional	\$145	\$175
<input type="checkbox"/> AVS-CVS-IVS Student/Spouse	\$80	\$95
<input type="checkbox"/> Non-VS Adult/Professional	\$175	\$205
<input type="checkbox"/> Non-VS Student/Spouse	\$95	\$110

OR

Daily Registration

- Tues, June 3 Wed, June 4 Thurs, June 5 Fri, June 6 Sat, June 7
 Adult/Professional \$45/day \$50/day
 Student/Spouse \$25/day \$30/day

On-Campus Housing

Rooms have been reserved at The Dobie Center and Jester Center Halls. All double rooms (2 single beds per room) are at Jester Center, where a complimentary breakfast is provided from Tuesday through Saturday. Each room has a connecting bath. All single rooms (1 bed per room) are at Dobie Center, where two rooms share an adjoining living area with a small kitchenette. Each room has its own bath. A limited number of these double and single rooms are available; please plan to register early. Rooms may not be available after May 15. Please note that rooms are available only for the full five nights, not on a day-to-day basis.

- I plan to stay on-campus I plan to stay off-campus
 Double occupancy (Jester Center) \$36 per night, per person June 3-7=\$180
 I would like to request a roommate Name: _____
OR
 Single occupancy (Dobie Center) \$44 per night, per person June 3-7=\$220

Banquet

We are excited to offer a Traditional Texas-Style Banquet under the dramatic backdrop of our 3,000 seat Bass Concert Hall and stage. In honor of this Silver Anniversary event, a couple of little surprises may just be in store for us! If you wish to attend, please add \$26 to your registration fees and check one of the boxes below.

- I will attend the banquet I will not attend the banquet

TOTAL AMOUNT DUE (REGISTRATION, HOUSING & BANQUET)

\$ _____

BIDDULPH RECORDINGS
in cooperation with
THE PRIMROSE INTERNATIONAL VIOLA ARCHIVE
presents

WILLIAM PRIMROSE



FIRST AND LAST VIOLA RECORDINGS

J. S. Bach: Solo Suites for Viola (Cello). *New release, recorded in 1978.*

Bach: *Komm süßes Tod*. Brahms: Two Songs. Massenet: *Elegie*. Rachmaninoff: *When Night Descends* (with Marian Anderson).
Dvorak: *Humoresque*. Nevin: *The Rosary*. Paganini: Caprices nos. 5, 13, 17; *La Campanella*. Kreisler: *Liebesfreud*. Schubert: *Ave
Maria*; *Litany for All-Soul's Day*. Tchaikovsky: *None but the Lonely Heart*. Londonderry Air (traditional).

*This two-CD set is a special limited offer to members of the American Viola Society.
Proceeds will go to PIVA and the new Primrose Room in the Harold B. Lee Library, Brigham Young University.*

\$29.95 (including packaging and mailing within the U.S.)

Please make check payable to Primrose International Viola Archive (PIVA)

Total number of sets _____ Amount of check: \$ _____

Name _____

Address _____

City _____ State _____ ZIP _____

Telephone (_____) _____

Mail to
Dr. David Dalton
BYU Music—HFAC
Provo, UT 84602

(Please allow 60 days for delivery.)

FROM THE PRESIDENT

Our Silver Anniversary Congress

Our tradition of excellence continues as we gather once again, this time for the XXV International Viola Congress at The University of Texas at Austin. An outstanding five days has been planned with world class artists, luthiers, clinicians, and scholars making this the most exciting congress yet. There will be exhibits of new music and quality instruments to inspect and to play. And, don't forget to bring your own instrument as there will be ample opportunity for you to participate—if you bring your favorite edition of the Bach Suites, you'll be in for a treat!

Many different groups and types of violists traditionally attend our congresses including orchestral musicians, university and college teachers, amateurs, public school teachers, viola makers, and scholars.

None are more important though than eager, enthusiastic, and idealistic students. Please encourage your students to attend; they will be awed, inspired, encouraged and, you will receive the immense pleasure of watching them grow.

Most important of all, we come together to create and re-create our common bond, to renew our collective soul, to unify our hearts, and to reaffirm the value of who we are and what we do. It is important that you attend.

Special thanks to our host chair, Professor Roger Myers, and to Dr. Ronald Crutcher, Director of the School of Music, for the planning, coordination, and administration of this congress. And, of course, our thanks to you—your participation in the Congress and in our society is vital for the continued strength of our organization.

Please accept my personal invitation to attend the Twenty-Fifth International Viola Congress. This is truly a special time for all of us.

I look forward to seeing you this June in Austin.

Thomas Tatton



(Left to right) Dwight Pounds, David Dalton, Pam Goldsmith, Jerzy Kosmala, Roger Myers, Lisa Hirschmugl, Don McInnes, Chris Rutledge, Bill Schoen, Tom Tatton, and Donna Clark

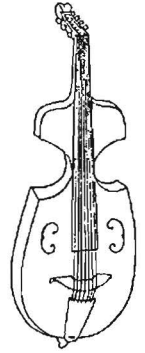

*Your AVS Welcome
Wagon Committee looks
forward to extending to
you a warm, Texas-style
welcome to
Viola Congress XXV
in Austin, 3-7 June 1997.*



Peter Zaret Violins^{inc.}

Violin Dealers, Makers, and Restorers
Finest collection of violins, violas, cellos, and bows

Quality, Performance and Service

Consignment - 100% Trade-ins - Appraisals
24 Hour Shipping on Approval

We invite your inquiry

1-800-222-2998 or email Zaret@exis.net
861 W. 46th Street, Norfolk, Virginia 23508

Graduate of Juilliard

Member of the Violin Society of America

Doctor of Musical Arts

VIOLA WORLD

Presenting...

A new addition to our Solo Repertoire:
"LAURETTA'S LAMENT" by G. Puccini, from
the opera *Gianni Schicchi*. This is truly
one of the loveliest melodies ever written.

Concert edition for Viola & Piano.

Arranged by Alan Arnold.

Price \$3.30

Available from:

VIOLA WORLD PUBLICATIONS
2 INLANDER ROAD
SARATOGA SPRINGS, NY 12866
PHONE & FAX: (518) 583-7177
e mail: violaworld@aol.com

SEND FOR OUR COMPLETE CATALOGUE

Lauretta's Lament

Arranged for Viola and Piano
by Alan Arnold, ASCAP

"O mio babbino caro" from GIANNI SCHICCHI

G. Puccini

ANNOUNCEMENTS

BE A CONTRIBUTOR TO OR BENEFACTOR OF THE AVS.

Your contributions are tax deductible
and are greatly appreciated.

(SEE MEMBERSHIP ENROLLMENT FORM IN THIS ISSUE.)

IF YOU LOVE THE VIOLA AND FEEL WARMLY
TOWARD THE SOCIETY OF VIOLISTS, WHO WOULD YOU NAME
AS A BENEFICIARY OF YOUR ESTATE?

*The AVS Endowment? or
The Primrose International Viola Archive? or
The Primrose Memorial Scholarship Fund?*

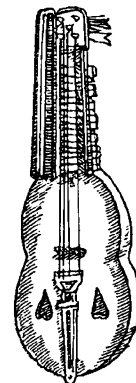

Surfing Pleasure

The Primrose International Viola Archive is now on the

Internet.

*Enjoy a general description, Primrose biography, examples
from the photo archive, sound bytes from his recordings, etc.:*

<http://www.lib.byu.edu/~music/PIVA/WP.html>



The de Veritch Institute of Viola Studies
presents

VIOLA CAMP '97
'WONDERFUL WORLD OF VIOLA PERFORMANCE'



August 2–12, 1997

An intense summer camp dedicated to the
practice, training, and performance of the VIOLA

directed by

Internationally known violist, recording artist, and pedagog

~ **Alan de Veritch** ~

To be held in Malibu, California, at the spectacular campus of
Pepperdine University, featuring breathtaking views of the Pacific Ocean

Program will consist of:

- technique & pedagogical workshops
- master classes in both solo & orchestral repertoire
- viola ensemble coaching & performance
- student & faculty recital performances
- guest lecturers
- supervised practice

*This camp is designed for talented violists of varied ages and expertise
(young students thru seasoned professionals). Applicants may enroll
either as playing participants or as auditors.*

For information & applications:

(812) 855-3043

de Veritch Institute
2711 Brigs Bend
Bloomington, Indiana 47401

JAVS Reader Survey Results

Editor's note: The following is a general analysis of the results of a survey that accompanied our JAVS December 1996 issue. This analysis is based on the responses of 159 readers, or about 20% of the AVS membership. A complete analysis and summary of the survey will appear in our next issue.

- 82% of respondents rated *JAVS* as “very good” or “excellent.”
- 83% of respondents rated *JAVS* information as “very valuable” or “valuable.”
- 84% of respondents keep *JAVS* for reference.
- 84% of respondents read each issue thoroughly or read some articles in detail.
- 89% of respondents indicated they would still subscribe to *JAVS* even if articles were made available on the Internet.
- 42% of respondents feel the primary function of *JAVS* is to inform, stimulate, and enlighten, while communication and a promoting a sense of community and unity are secondary functions.
- Respondents would like to see *JAVS* incorporate a greater quantity of items in these categories or regular departments: feature articles, interviews, “Viola Pedagogy,” and “About Violists.”
- Lead articles and “Viola Pedagogy” are the top features enjoyed by respondents.
- Most frequently suggested as desirable additions to *JAVS* were more articles on pedagogy and coverage of viola and bow makers.
- About 50% of respondents indicated a desire for some changes to *JAVS*.
- 45% of respondents are teacher/professional musicians combined.
- More than half of *JAVS* respondents read *Strings* and *Strad* magazines, while one third and one quarter of *JAVS* readers, respectively, read *CMA* and *ASTA*.
- 76% of respondents refer to *JAVS* when seeking a service or product.
- 67% of respondents have made contact with a *JAVS* advertiser.
- 43% of respondents had not attended a previous viola congress, citing schedule conflict, financial constraints, or distance as the main obstacles to attendance.

Prize-winning respondents drawn from submitted surveys are:

Meme Pittman, Schenectady, New York
(2-CD set, Primrose: “The First and Last Viola Recordings”)

Karen Griebing, Conway, Arkansas (*Playing the Viola: Conversations with William Primrose*, by David Dalton)

Michael Laurence Hall, Greensboro, North Carolina (*Walk on the North Side*, by William Primrose)

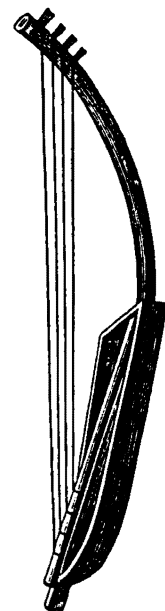

*Please patronize our
JAVS advertisers,
who help make this publication
possible—*

Composers and publishers should submit
new works to the editor
for possible reviews in *JAVS* and deposit in *PIVA*.





NEW YORK LEGENDS

is a collection of
12 CD's featuring
the principal players
from the New York
Philharmonic –
91 works, 30 world
première recordings
and 50 American
compositions.

Cynthia Phelps

PRINCIPAL VIOLA, NEW YORK PHILHARMONIC

With Judith Gordon, *Piano* and Jeanne Baxtresser, *Flute*



Performing Benjamin Britten's *Lachrymae* for Viola and Piano, Francois Devienne's *Two Duos, Op. 5* for Flute and Viola, Georges Enesco, Concertpiece for Viola and Piano, Paul Hindemith's Sonata for Unaccompanied Viola, Robert Schumann's *Märchenbilder* for Viola and Piano, and the world première recording of Stephen Paulus's *Five For The Flowers Near The River* for Viola & Piano

"Violist Cynthia Phelps' recital Sunday amounted to a portrayal of a young performer of the top rank. The sounds she drew from her instrument were not only completely unproblematical - technically faultless, generously nuanced - but sensuously breathtaking."

— BOSTON GLOBE

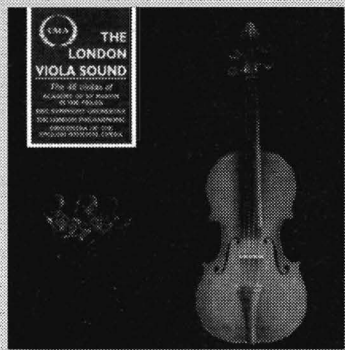

The London Viola Sound

The 48 Violas of Academy of St. Martin in the Fields, BBC Symphony Orchestra,
The London Philharmonic, Orchestra of the English National Opera.

Geoffrey Simon, *Conductor*

GERSHWIN - It Ain't Necessarily So; WEILL - Kiddush, Rivka Golani, guest soloist;
SHOSTAKOVICH - Galop from Cherymushki; DVOŘÁK - Slavonic Dance in E Minor; GRAINGER
- Arrival Platform Humlet; RAVEL - Pavane pour une infante, défunte; PROKOFIEV - Waltz from
War and Peace; BACHARACH - This Guy's In Love With You; STRAYHORN - Take The "A" Train.

"The recording is full-toned, spacious and very easy on the ear. This is a disc that a collector would return to and be tempted to play demonstration items - especially the Shostakovich - to entertain visiting friends. Recommended."

— GRAMOPHONE MAGAZINE, September 1995

CYNTHIA PHELPS, Viola — CACD 0510 — \$13.98 plus shipping & handling
THE LONDON VIOLA SOUND — CACD 0106 — \$7.98 plus shipping & handling
Order by phone: In the US 1-800-879-2252 • In the UK 44-181-883-7306

Cala Records, Inc. • 3214 Doroteo Way, Sacramento, CA 95833 • 1-800-879-2252 • Fax 916-925-2255
Cala Records, Ltd. • 17 Shakespeare Gardens, London, England N2 9LJ • 44-181-883-7306 • Fax 44-181-365-3388
Email: info@calarecords.com

FIFTY YEARS IN THE HOT SEAT

An Interview with Joseph de Pasquale



De Pasquale (right) with Serge Koussevitzky & the Boston Symphony Orchestra, Tanglewood, ca. 1950

JOSEPH DE PASQUALE, who will be the dedicatee of the forthcoming XXV International Viola Congress, was interviewed October 1996 in Provo, Utah, by *JAVS* editor David Dalton.

Dalton: 1996 marked the year of your retirement after fifty years as principal violist of two major symphony orchestras in this country—actually in the world—the Boston and the Philadelphia. When did you first sign your contract with the Boston Symphony Orchestra?

De Pasquale: In the spring of 1946, and then I played the summer season in Tanglewood with the BSO. That makes a few months short of fifty years, but you can round it off to that number. I was at Boston for about twenty years, and then went to the Philadelphia orchestra in the same position for the other thirty.

Dalton: That's when your professional career as a principal violist began. But when did it all start? Tell us a little about your background,

your heritage, your parents. How were you introduced to music, particularly to string playing?

De Pasquale: My father was a violinist; his name was Oreste—a name that I happen to like, by the way. I don't know why, but people called him Horace—which is actually *Orazio* in Italian. I was the oldest child and he started me on the violin, and after that, my brothers Bill and Bob started. One brother, Francis, wanted to play cello, but since my father didn't teach cello, he sent Francis to a friend who did.

I studied with my father for a number of years, first in south Philadelphia where I was born, and then in Germantown, where we moved when I was about nine years old.

Dalton: A little more about your father—where did he come from and where did he get his training as a violinist?

De Pasquale: He was born near Cosenza, a small town in the southern part of Italy, and came to America when he was very young.





Interestingly, my mother came from the same town, but they never knew each other in Italy. They met for the first time in Philadelphia. Unlike my father, she was not musical, but she appreciated good music.

My father trained in Philadelphia with Lucius Cole, an excellent violinist who was also the father of my Curtis Institute colleague of many years, Orlando Cole, the cellist. Lucius was a product of the Franco-Belgian School of violin playing through Cesar Thomson. So I had that schooling long before I went to Primrose, who of course received the same training through his teacher Ysaye.

My father became quite adept at the violin and was a wonderful teacher. He had lots of private students, whom he taught for a dollar a lesson. By profession, he became a cabinet-maker and refinisher because you couldn't earn a living back in the 1930s by teaching for a dollar a pupil. When he thought I got too good for him at about the age of fourteen, he sent me off to Lucius Cole. I studied with him for about two years then had an audition at Curtis.

Naturally, when you're young, you think you play pretty well. But it was finally decided I would be accepted at Curtis as a violin student of Léa Luboshutz, of the Luboshutz-Nemenoff piano duo. (She had been a fine violinist also.) Jascha Brodsky and Max Aronoff pulled me aside and said, "You don't want to study with her. Why don't you take up the viola and study with Max Aronoff and Louis Bailly?" Bailly was violist in the Flonzaley Quartet and teaching at Curtis. "You'll make out as a violist much better than you will as a violinist."

I probably would have ended up last stand as a second violinist some place scraping away on the fiddle. They told me I was built for the viola—long arms, big hands, and broad shoulders. Of course, in those days I was muscular and much thinner, without the stomach I now own. In the beginning, I wasn't too enthused because I didn't feel like playing mostly harmony. I wanted to be playing the melody all the time. But I talked it over with my father and we both decided it would be better for me to make the switch. Brodsky asked me just recently, "Aren't you

S·H·A·R

Serving String Musicians for Over 33 Years



- *Rare and Fine String Instruments and Bows*
- *Over 7,000 Sheet Music Titles Available*
- *Classical Books, Videos, Strings, Accessories, and More*
- *Free 64-page Catalog Upon Request: 1-800-248-7427*



Shar has the nation's only written "60-Day No-Risk Instrument Return" policy.

Applies to any violin, viola, or cello over \$600.00 when returned within 60 days from date of purchase
We invite your inquiries from USA and Canada: 1-800-438-4538 (Fine Instrument Department)



Shar Products Company
 P.O. Box 1411 • Ann Arbor, MI • 48106





Louis Bailly teaching at the Curtis Institute in a drawing made by a student in the 1940s.

glad you took our advice and switched to the viola?" I surely am.

Dalton: In the meantime, you've certainly had plenty of chances to play melody on the viola. Had you been condemned to the back of the seconds, you would seldom have had the melody. At Curtis did you go immediately to Aronoff or to Bailly?

De Pasquale: Both. I had one hour a week with Bailly on repertoire and, with Aronoff, two hours a week on just plain scales and technique: Sevcčák, Fiorillo, Rode, Kreutzer, Sauzay—a very good book for intonation—and Campagnoli. By the way, I give my pupils the Primrose version of the *Campagnoli Caprices* and they don't like it because it goes all over the fingerboard. I say, "Do it. It's good for you!" All this built my technique. I was kind of a wild player in those days and Aronoff tamed me down a bit. I worked with a metronome and this was all good for me. With Bailly I studied a lot of French repertoire, the Enesco *Concertpiece*, for instance. Also, the Bach suites and the

Rebecca Clarke sonata, a wonderful piece. I met this frail little English woman—you would never have suspected such healthy music could come from her.

Dalton: I assume you graduated from Curtis after four years' study. What year was this?

De Pasquale: It was 1942, and the war was on. I joined the Marine Corps because I had a chance to get into the Marine Band in Washington, D.C., where I played . . . yes, trumpet! They handed me a trumpet and said *here!* I was taught by the principal trumpet player of the band. I remember being out of breath and having headaches as soon as I started playing. I wasn't playing correctly and it was quite a trying experience. I played only the notes "in the cellar," those nearer the bottom of the staff. If I ever went above that, I cracked.

I also had to play in the orchestra—this time as a violist. We had our White House contingent, for instance, and played at all the state dinners. I was at the White House many times, and after the state dinners they would feed us and serve cake and sensational ice cream. Roosevelt was president, and after the guests were gone, we marines would all scramble to sit in FDR's chair. I made it once in over three years, even got his gold engraved place card.

One day we were marching in the band at Marine headquarters after it had snowed, and I slipped on the ice. Trying to save myself from falling, I came down right on top of my trumpet and turned it into something like an accordion. For that I was given a penalty and had to copy music for a month. I said, "I slip on the ice and you give me a penalty?" I resented that, and at the end of the war, they asked if I wanted to stay on—I was offered a staff-sergeant rank. I said, "Are you kidding? I wouldn't stay on if you made me a general!"

Of course, I knew in those days I could have been less lucky and been a stretcher



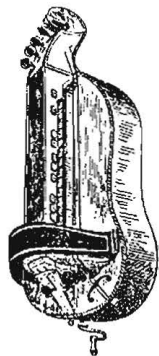

bearer someplace on the front, for instance. Stretcher bearers got shot.

Dalton: When did you first encounter your idol, William Primrose, and what did you especially gain from him?

De Pasquale: While I was in Washington, Primrose joined the faculty at Curtis. I used to go up every other week to study with him. That went on for a couple of years. He said he wouldn't have to teach me much. Ha! He taught me how to bow. I had no bowing technique to speak of—held my elbow way up. He used to come and hit me on the arm and knock it down. His system of scales and technical exercises also helped me enormously. Musically, I learned as well. His phrasing was unbelievable; it left me with my mouth literally open. He played a difficult passage in the Walton with such ease, it disgusted me, and I said, "I could never do that."

But he said, "You will do it. Just observe and listen to what I say."

I said, "Okay, I'll do it in fifteen or twenty years—maybe."

The colors he produced with his bow were really a revelation for me. He was such a fantastic artist.

Dalton: When you got out of the Marine Corps at the end of the war, what did you have in mind as the next phase of your life and career?

De Pasquale: I went to New York because I heard there was an opening in the viola section of the American Broadcasting Company Orchestra. Joe Sopak conducted the symphonic repertoire, and the popular stuff was conducted by Paul Whiteman. Whiteman was an excellent arranger, had a baton about a yard long, was lots of fun, and I enjoyed him very much. He was a violist, and do you know what he called the viola? The chin bass!

Emanuel Vardi was principal of the ABC orchestra, and I was his stand partner. Manny has a formidable technique, as you know, and we tried to

"outdo" each other. After awhile, I would say, "Stop, Manny, I don't want to hear anymore of you. You make me sick!" Lots of fun. I was earning \$225 a week, which was a lot of money. I bought a new car every year and would buy my brothers bicycles and other things.

Dalton: Up to this point, what viola had you been playing on?

De Pasquale: I bought a Storioni from Efrem Zimbalist, a viola he had gotten for his first wife, Alma Gluck. She was a famous singer, of course, and also played viola. That was at the end of my studies at the Curtis Institute when Zimbalist was its director. The viola was sixteen and a quarter inches long. I enjoyed that viola very much, but I wanted a larger one, and a bigger sonority. I later sold it, don't know where it is today, but wish I still had it.

Dalton: After the ABC Orchestra in New York City, what was the next step in your career?



De Pasquale as a student at the Curtis Institute, 1940

De Pasquale: The announcer of our broadcasts at ABC, whom I had gotten to know very well, told me one day, "Joe, I hear there's an opening in the Boston Symphony. You should try out for it." Koussevitsky was the director, and I thought to myself that I would never make that one—I would faint in front of him. But I decided to try out, figuring I had nothing to lose. I went to Boston for the two-day audition in March 1946, and when I arrived I saw this slue of thirty-five violists who were all auditioning for the position, among them some pretty eminent musicians.

I told myself, "This is impossible, I'm going home. I won't play!" Well, I played anyway. We had to play *Harold in Italy*, *Don Quixote*, and other principal viola solos. I sightread Hindemith's *Mathis der Maler*, the Mozart G-minor Symphony, and the last movement of the "Haffner." Koussevitsky must have liked something. The group was narrowed down to about five, then to two of us. By then I was so nervous I couldn't see straight and wondered what was going to happen. I imagined all sorts of horrible things. But one thing I never imagined was that I might get the job.

The manager came out, sent the other player home, and told me they wanted to hear me again. I had already played Walton and the Brahms E-flat Sonata. Koussevitsky said, "Mine dear, I want to hear something classical." I said that I had played the Handel Concerto at one time. "Oh good, good, the Handel." He apparently knew it and sent someone out to try and locate a copy. I waited and thought that my nerves couldn't hold out much longer. So I went ahead and played the first couple of pages for him, as much as I could remember. Then silence. I was told to wait in the next room. Finally the door opens and Koussevitsky comes out wearing his black cape—he looked like Dracula. "Mine dear Mr. Pasquale, you are my new first viola."

I almost fainted—couldn't breathe. I flew back to New York that night but don't even remember going to the airport, I was in such

KENNETH STEIN VIOLINS

Expert Repairs & Restorations

Large selection of
fine Violins, Violas, Cellos and Bows

(847)491-9550

1320 Sherman Avenue.
Evanston, IL
60201



a daze. I called home and told the news to my parents, my brothers, and then my girlfriend. (That one didn't materialize, by the way.)

Dalton: How did you fare in your first season with the BSO and your viola section? Were you taken in graciously?

De Pasquale: Yes and no. You see, financially, I was doing well making \$250 a week—which was eventually raised to over \$500. But I was twenty-six and felt a bit of opposition. "What's with this young guy coming in?"

It was almost a complete French viola section; about five of them former students of Maurice Vieux. There was one American and two from Germany. I thought I was in a foreign orchestra. Practically all I heard spoken was Russian, German, and French, with a smattering of English. Koussevitsky rehearsed in English—if you want to call it that—and I was always leaning over trying to get a translation. He had conducted in Paris before he came here, Monteux had preceded him at Boston, and together they brought a lot of French players into the BSO. And I had a stand partner who was not too friendly in the beginning. He failed to show me some of the pitfalls in the pieces we were playing, and we hardly rehearsed.

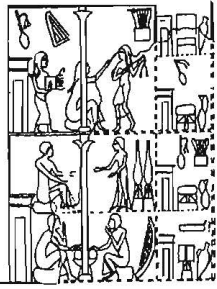

We were doing Sibelius's Fifth Symphony in a concert, and at the end of the last movement there is a series of isolated chords. My partner didn't tell me that Koussevitsky conducted only those chords and none of the rests. I was counting, I thought a downbeat came, and I entered—*WHAMO!* There was only one consolation: it was in tune. But in the wrong place. Koussevitsky turned and looked at me with that famous vein almost popping out of his forehead.

I felt so small and wished I could find a hole to fall into. I thought, "Fine, he'll fire me tomorrow." I was called up the next day to Koussevitsky's room and he said, "Mine dear, how you can, how you can do? Didn't Cauhapé tell you rests and beats? No? I vill den talk to him."

After that, Cauhapé warned me about all the pitfalls. It never happened again.

Dalton: During what season were you first invited to play a solo with the BSO?

De Pasquale: Second year, and for about ten times it was *Harold*, which we took on tour to Chicago, New York, Washington, Baltimore, etc. With Charles Munch, who was Koussevitsky's successor, I later played Walton and Bartók. One of the great experiences of my life was when I soloed with Monteux, a former violist as you know, in Bartók. He was wonderful. I did the recording of *Don Quixote* with Piatigorsky, and Munch conducting.

Besides those I mentioned, other conductors I particularly admired were William Steinberg, who I thought was wonderful, and Igor Markevich. I also liked Ferenc Fricsay, the excellent Hungarian conductor, who died at forty-five of cancer. A real shame.

Then there was the tragic accidental death in November 1956 of Guido Cantelli, a favorite of mine. That was on the front page of the *Boston Globe* because he was going to come and conduct us. I usually went out mornings and got the paper, but that day I couldn't find it. I found out later that my

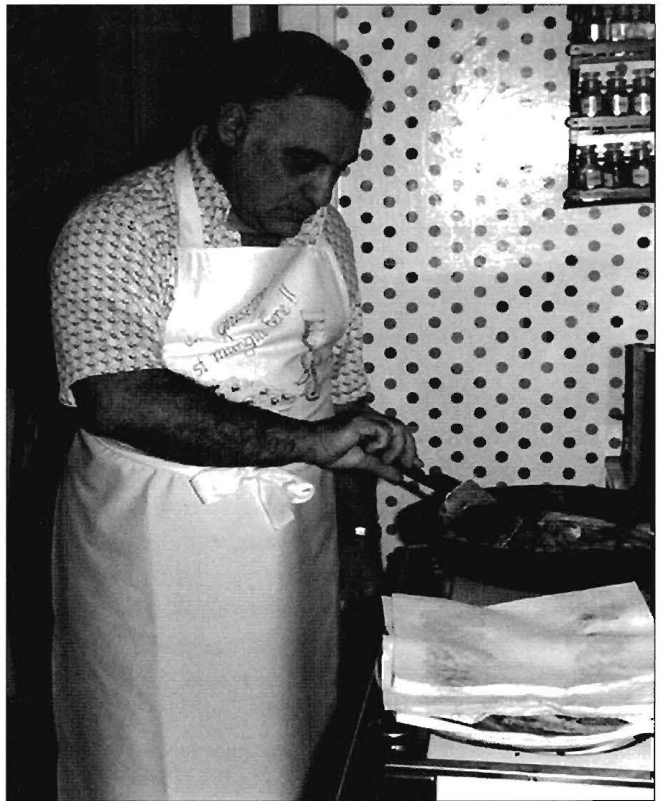

Joseph de Pasquale in the kitchen, Merion, PA, ca. 1984

wife Maria, seeing the headlines and knowing what my feelings would be, had hidden it from me. I didn't get the news until I went to rehearsal. I just started to cry. Cantelli was a good friend and I admired him so. He would have been the successor to Toscanini at NBC. (Toscanini's aids kept the tragedy of his "prodigy" from the maestro as long as they could. As I remember, Toscanini died a couple of months later.)

Dalton: At the Tanglewood Festival, were you not in an advantageous spot to meet conductors of the rising generation?

De Pasquale: Zubin Mehta and Claudio Abbado, for instance, were both students there and I liked them very much. They were practically kids at that time in the conducting class. Maria had heard about them and insisted that I go to an evening's concert where they would both be conducting. I had already put in eight hours that day coaching and teaching, and I said that I wasn't going. I was simply too tired and I didn't want to hear any more music. She told me that one was Indian and the other Italian. I said that I didn't care

what they were, I didn't want to go. But Maria convinced me, I went, and it was a revelation. Zubin conducted *Don Juan*, which was excellent, and Abbado the "Unfinished" Symphony. He did something with it, and I said to myself, "They are both going to go places." And they have. I did some cooking then, and I had them over for dinner because I liked them.

Dalton: You mention your wife. Wasn't your nuptial celebration, perhaps your wedding, associated some way with the Tanglewood Festival, the BSO? And didn't Koussevitsky somehow figure in?

De Pasquale: Our wedding took place at Tanglewood in 1949. Maria is Koussevitsky's niece through marriage. She would hang around the rehearsals. She looked at me and I looked at her and I thought "That blonde isn't bad at all!" She was a beautiful woman, Maria Magdalena von Leuchtenberg de Beauharnais. An ancestor of Maria's was the wife of Napoleon. Maria was born and educated in France and then in Germany and is fluent in about five languages. She arrived in the U.S. just after World War II.

Dalton: Any orchestra concerts during those Boston years, or with soloists, that particularly stand out in your memory?

De Pasquale: Early in my experience, Heifetz came to record the Mendelssohn and the Prokofiev G-minor Concerto. He hadn't soloed with Boston in years, and when he started to play, to my ears all the others who had come before him sounded like students in comparison. You could have heard a pin drop when he came out on stage to rehearse. He was unbelievable. When Piatigorsky came to us, it was always an event. Horowitz was dazzling, and when Rubinstein played, it was just beautiful. He missed notes, but so what?

Before Primrose came to play and record *Harold*, Munch asked me, "Why should we have Primrose? We have you here."

"Look, there's a difference—a big difference. Please invite him," I said. As it turned out, when Primrose came, I was glowing, but

Munch was livid because there were passages in his playing that were out of tune.

"What's the matter, he's supposed to be great," Munch said.

"He has troubles with his hearing because of a fever he had, but, please, we must go ahead with the recording"—which we did. I sat back in the booth with Primrose and coached a little by just suggesting, "Bill, I think we should do this passage over again." He looked frantic. Nevertheless, the recording turned out pretty well.

Dalton: That particular *Harold in Italy* was the best selling classical recording of the year. You took Primrose's place in some recordings with Heifetz and Piatigorsky. How did that come about?

De Pasquale: This was some years later when I was back in the Philadelphia Orchestra. I got a phone call one day from George Judd, Heifetz's manager: "I'm calling you because, if you can do it, Mr. Heifetz would like very much to have you play in a concert with him at Carnegie Hall."

I thought someone was pulling my leg. "Who is this?" I demanded.

"What do you mean, who is this? I'm George Judd!"

I thought I had better go along with this because it all might be true.

"Heifetz is going to call you tonight at precisely eleven o'clock so you had better be at home."

"Precisely?" I thought, this is all a big joke, but like a damned fool, I waited by the phone that night. At two minutes to eleven the phone rings.

"Hello, this is Mr. Heifetz."

I still thought someone was trying to take advantage, but thought I'd better be careful because it may be him. I noticed that his accent sounded somewhat Russian—maybe it was him. He asked if I could play a concert with him on such and such a date at Carnegie Hall. I said, "Of course, yes—of course. I can—yes!"

But I had to get time off from the Philadelphia Orchestra. I had heard that Heifetz and Ormandy didn't get along in the later years. Something about Heifetz insisting on



MUSICAL INSTRUMENT INSURANCE



- All Risk--Worldwide
- Low Deductible
- Major U.S. Insurance Company
- One Policy--No Limit
- Broadest Policy Conditions Obtainable

**Lowest Rates in the
United States--
Perhaps the world!**

**The leading choice of soloists, ensembles
and orchestras throughout the country.**

LIABILITY INSURANCE

- Flexible Coverage
- Equipment Coverage
- Annual & Special Event Policies

**The Performing Arts
Insurance Program
You've been asking for!**

CLARION ASSOCIATES, INC.
1711 New York Avenue, Huntington Station, NY 11746
516-423-2990



The de Pasquale Quartet with Eugene Ormandy and the Philadelphia Orchestra, ca. 1965

being last on the program and Ormandy wanting to close the program with his orchestra. Petty things. But I told Ormandy about the concert, he was happy, and I got a week off. I went to New York to a small hotel, the old Salisbury. I still wasn't quite believing all this until I got up to the room, knocked on the door, and Heifetz opened. Then I knew it was true and I started getting nervous! Being about three feet away during rehearsals was a revelation to me, something hard to believe. We played the Dvořák Piano Quintet and the Françaix String Trio—a piece I really had to work on.

After that concert Heifetz asked me to come out to Hollywood to record the Françaix and the Dvořák. Heifetz asked me if I wanted to play the next year with him in New York. We performed the *Souvenir de Florence* with a second viola player, Harold Coletta, and the Spohr double string quartet, for which I got my brother William to join us. I was invited to do these things with Heifetz through Piatigorsky's recommendation. We had done *Don Quixote* together years before.

Dalton: How long did you stay at Boston and why did you leave?

De Pasquale: Seventeen years exactly, and Leinsdorf had taken over as conductor.

Ormandy had been after me for years to come back to my hometown and play in his orchestra, the Philadelphia. I said, "No, I can't come back, and besides, my wife doesn't want to leave Boston. Her mother's here and also her aunt, Koussevitsky's widow." So Ormandy got on the phone with me and then on the phone with Maria and talked to her for an hour. He was very persistent. I would get a raise, but the icing on the cake was when I received a letter from Zimbalist asking me to be on the faculty at Curtis. "Maria," I said, "I can't refuse this." Ormandy probably orchestrated the appointment, but I was lucky there happened to be a vacancy at the time, which was 1963.

As luck would have it, after a year and a half with the Philadelphia Orchestra, they went on strike for about nine weeks. We had four children, had just bought our house in Merion Station, were making mortgage payments, and our savings started to disappear. Maria started looking for work and got a job as a librarian. It was all quite a mess.

Dalton: What about your string-playing brothers, whom you have mentioned? Were any of them in the Philly to welcome you back home?

De Pasquale: Francis was in the cello section and William had come to the orchestra a year





before Robert and I joined. Robert became assistant principal in the second violin section, and William is now an associate concertmaster. We brothers had played together as a quartet for years—that is, whenever we could get together with a few concerts here and there. We found out that the de Pasquale Quartet was the only professional quartet made up of brothers—the only brothers quartet in captivity. Francis died about 1973. Sammy Mayes took his place in the quartet, then Gloria de Pasquale—my brother Bill's wife.

Dalton: The Philadelphia Orchestra was certainly at its strongest at the time you came in.

De Pasquale: Absolutely. It was a great orchestra, different from the Boston Symphony, which was also a marvelous orchestra. But I had grown up with the Philadelphia Orchestra sound of Stokowski in my ears, that beautiful, voluptuous, sensual string sound handed down through Ormandy, who was a string player himself. One of my solo highlights was playing for the first time with orchestra the Bloch Suite. I had to revise my bowings after the first rehearsal

because the music has such a gigantic orchestration. Another was when the de Pasquale Quartet gave the Philadelphia premiere of the Benjamin Lees piece for string quartet and orchestra, a good work. After one of our concerts, a man came up to me and said, "Mr. de Pasquale, I'm Sergio Peresson and I want to make a viola for you." I said, "No, thanks," because I had had similar experiences with other makers, and I didn't like to tell them that I didn't like their instruments. It's like telling an artist you don't like his painting. But he insisted again later and entreated me to accept his offer. I gave in, but I told him not to be insulted if I didn't like his instrument. A half year passed and I get a call that my Peresson viola is ready. It had been strung for only a week and I thought, "Wow! It sounds wonderful." I liked it so much I gave Peresson a kiss. Ever since I have kept this marvelous viola, which gets better with age—while the player gets worse.

Dalton: I take it you had your Gaspar up to the time you acquired the Peresson.

De Pasquale: I bought the Gaspar in 1957, while I was still in Boston, and before that I'd

Samuel Kolstein & Son Ltd.

**International Luthiers & Bowmakers
Custom Made Instruments & Bows**

VIOLIN - VIOLA - CELLO - BASS



*Extensive Sales Repairs Accessories Department
Student or Professional Requirement*

Members of the Appraisers Association of America

**795 Foxhurst Road, Baldwin, New York 11510 Phone (516) 546-9300
Fax # 516 546-9309**

had a Giovanni Battista Cerutti that Eugene Lener of the Kolisch Quartet bought from me.

Primrose had warned me, "Joe, I wouldn't buy it. It's too big." It was 17 ³/₈ inches and the ribs were wide. But I said that I loved the sound. Nevertheless, I started having pains in my wrist when I went up into the third or fourth positions. It felt more like I was in the tenth. After I got the Peresson, I sold the Gaspar and bought my farm west of Philadelphia. By then I enjoyed the farm more than I did the viola. Besides, the Peresson was simply a wonderful replacement.

Now Ormandy noticed everything in the orchestra around him. One day he looked at me and said, "What's wrong with your Gaspar? You haven't had it here for at least a week."

I said that I may sell it.

"No you won't. It's a magnificent instrument," he said.

I said that I was just trying this instrument. Then one day I asked, "Mr. Ormandy, what are you doing after rehearsal today? I would like to play for you." He listened to my Peresson and said he enjoyed it very much, and asked what it was.

"It's a Guarneri del Gesu," I said.

He thought awhile then said, "Del Gesu? He never made violas."

"I know . . . I meant Pietro Guarnerius. Do you like it?"

"Yes, marvelous," he said.

"That's why I want to sell my Gaspar."

He didn't mind, but when he heard that the instrument was really only three weeks old, Ormandy about flipped his lid because he never liked modern instruments.

"Mr. Ormandy, you said you liked this viola," and he couldn't go back on his word. I had him!

Dalton: Would you comment on some of the pieces that have been written for you. The Rochberg Sonata, for example, was composed in honor of Primrose for his seventy-fifth birthday, but with you in mind.

De Pasquale: That's right, I had consulted with the composer while the piece was still in manuscript. I premiered it with Vladimir Sokoloff at the 1979 Viola Congress in Provo.

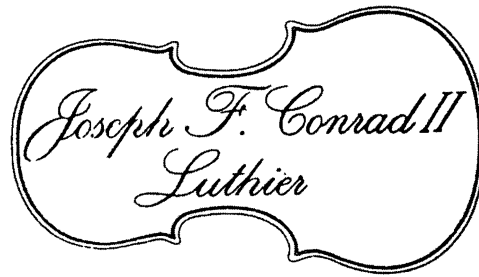

*. . . maker of
fine string instruments*

*By appointment
(980) 356-3712*

*15-A North Road
Warren, New Jersey 07059*

Primrose sat on the front row and made me nervous as hell.

Years earlier, while I was in Boston, Walter Piston came to me one day after I had played Walton and said, "Joe, I must write a viola concerto for you. You'll hear from me." I've had composers say that before and I learned to let it go in one ear and out the other. Piston used to come to every one of our Friday afternoon concerts. You could spot his gray hair in the hall. Wonderful gentleman. Six months later he told me he had the first movement completed and part of the second. I said, "May I see it?"

"No, I don't want any influence from you. When it's finished, then I'll show it to you. And if there is anything that seems cumbersome, we'll change it if you have good suggestions."

I did have a few. I gave the premiere and about ten performances, the first naturally in Boston, then New York, Washington, Baltimore, Cleveland, and other cities.

Dalton: What of your teaching duties at Curtis? Do you have a particular teaching philosophy or approach?

June 29 - July 21, 1997

*A comprehensive program designed
for talented young musicians
in an inspired setting*

California Summer Music

at the
Robert Louis Stevenson
School at Pebble Beach

*For ages 12 through 20
Chamber music; Private
lessons; Master classes;
Performances for strings &
piano; Musical composition*



THE FACULTY

Timothy Bach
Piano
Susan Bates
Viola
Zakhar Bron
Violin
Rostislav Dubinsky
Violin
Luba Edlina
Piano
Peter Lewis
Composition
Andrew Tuchansky
Cello
Zaven Melikian
Violin
Marina Gusak-Grin
Piano
Irene Sharp
Cello
Wendy Sharp
Violin
Basil Vendryes
Viola

Applications

236 W. Portal Ave., #104
San Francisco, CA 94127
1 500 442 3556
f 415 753 8934

Information

415 493 1545
f 415 858 2075

Irene Sharp

Artistic Director

Deadline: April 7, 1997

De Pasquale: There were always several viola teachers at Curtis. I usually taught four or five students, and the school carried a total of twelve violists in the Curtis Orchestra. I teach the viola orchestral repertoire class. Some of my former students have done well in the profession—for instance, Roberto Diàz, who is my replacement as principal in the Philadelphia Orchestra. Over half of that section are violists I have taught. Randy Kelly is principal with the Pittsburgh Symphony, and Tom Turner was recently appointed principal of the Minnesota Orchestra. My students are scattered all over the country.

In my teaching I always have Primrose in my ears, and I have tried to use him as a model in my own playing. *Tried*, I said. I have used his scale system and kept his wonderful and fantastic artistry in mind. And I have tried to instill some of these principles in my pupils. You don't just play notes; you do something with them. His wonderful bow technique and his beautiful sound are still an inspiration.

Dalton: You have taught over thirty years at Curtis. Do you find any difference, generally, in the students of thirty years ago and those of today?

De Pasquale: I think, with some exceptions, they were better, say, fifteen years ago—which doesn't mean that I don't have good students now; I do. And there are wonderful talents today. I'm not sure why, but it just seems I had more of them some years ago. I do have a little concern about my pupils' futures. But if they work hard and do what I try to tell them to do, they will do well.

Dalton: Do you think the viola has gained status during your lifetime?

De Pasquale: Absolutely yes. For one reason, good violinists—not just bad ones, as once was the case—take up the viola. You have to be good on the violin to be good on the viola. There are some very fine players these days. In my viola orchestral repertoire class, I hear all the Curtis violists and know how each is playing. I told them just last week, "Look at *Zarathustra* because I may want you to play it for me anytime and I'm not going to tell you when. I want a clean part with your own fingerings—just like I do with the concertos I teach. I want to see what you come up with." If they aren't prepared, they know they will be embarrassed because they will be asked to play it alone, even if they have to sightread it.

Dalton: If you had a particularly talented student come along today, would you recommend becoming a professional, perhaps principal, violist for the next fifty years—into the mid twenty-first century?

De Pasquale: Yes, I think I would, because it has been a very enjoyable fifty years. It was tough at times—plenty of pressure—but I enjoyed it. Actually, it doesn't feel like it has been fifty years. Good life, beautiful music. I'm glad to this day that I took some good advice and switched to the viola. As you know, David, I have simply had a love affair with the viola. ∞

Practice Violas

*When you travel
and don't want to take your good instrument
but wish you could still practice*

*Take one of our
travel & practice violas.*

*These instruments are fairly quiet
and can fit into your suitcase!*

Ernest Nussbaum

*6009 Johnson Ave. Tel (301) 530-7316
Bethesda, MD 20817 Fax (301) 493-4867*

Travel violins and cellos also available.

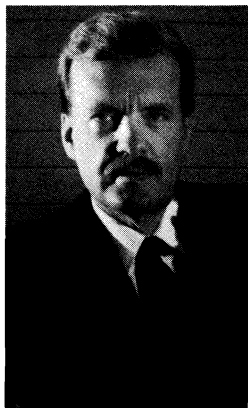

DAVID DALTON studied at the Vienna Academy, the Munich Hochschule, and took degrees at the Eastman School and Indiana University, where he earned his doctorate in viola under William Primrose. He collaborated with his teacher in producing the Primrose memoirs *Walk on the North Side* and *Playing the Viola*. He served as president of the American Viola Society.

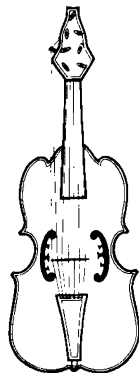

CLYN BARRUS is a graduate of the Curtis Institute, the Vienna Academy, and the University of Michigan, where he earned his doctorate in viola. He was principal of the Vienna Symphony and for thirteen years occupied that same position in the Minnesota Orchestra. He has been heard frequently as a soloist and recording artist, and is now director of orchestras at BYU.

The **Primrose International Viola Archive**, the largest repository of materials related to the viola, is housed in the Harold B. Lee Library. BYU graduates find themselves in professional orchestras and as teachers at institutes of higher learning. B.M., B.A., and M.M. degrees in performance are offered to viola students.

For information, write: Walter Birkedahl
School of Music, C-550 HFAC
Brigham Young University
Provo, UT 84602
Tel (801) 378-3294

"BYU is the Best Buy in U.S. higher education"

—*U.S. News & World Report*
25 September 1995

at

B R I G H A M Y O U N G U N I V E R S I T Y



William Moennig & Son, Ltd.

Locust Street, Philadelphia, PA 19103

***Since 1892,
Dealers, Restorers, and Appraisers in Rare
Violins, Violas, Cellos, and Bows***

MEMBER: ENTENTE INTERNATIONALE DES MAITRES
LUTHIERS ET ARCHETIERS D'ART

ART AND ANTIQUE DEALERS OF AMERICA, INC.

APPRAISERS ASSOCIATION OF AMERICA

FOUNDING MEMBER, AMERICAN FEDERATION OF VIOLIN
AND BOW MAKERS

VIOLIN SOCIETY OF AMERICA

Officers: William H. Moennig,
William R. Moennig, Pamela J. Moennig

Associates: Philip J. Kass, Richard Donovan

(215) 567-4198, (800) 523-4051, Fax (215) 567-4175
e-mail: PJKASS@worldnet.att.net

VIOLA PEDAGOGY

Four Basic Bow Strokes to Develop Rich Sound

by Pamela Ryan



The four basic bow strokes, *détaché*, legato, *collé*, and *martelé*, cover a wide range of tonal color. Working on these strokes, a player develops a good concept of sound and an understanding of the relationship of sound to the physical coordination of the bow arm and body. Of course, other factors contribute to a good tone—there is no substitute for a properly adjusted viola. Additionally, posture, intonation, musical feeling, style, talent, sensitivity of the ear, aesthetic judgment, and experience also account for a violist's tone. The bow strokes used in music to express character are myriad, but only the four above-mentioned strokes and their relationship to tone will be examined in this article.

Traditionally, learning to produce a good tone begins with legato. There are, however, many advantages to starting with *détaché*. The *détaché* stroke combines motion and weight in the middle of the bow, avoiding the extremes of bow arm position at the ends of the bow. After students solve typical problems of the elbow, arm, and shoulder in *détaché*, they can proceed naturally to the study of legato. In many ways the legato stroke is just a slower, more sustained *détaché* utilizing the whole bow, with new opportunities for arm and hand coordination. In these strokes, the emphasis is on playing “into the string” for an open and rich sound, made possible by a free and relaxed arm. Added to these two basic strokes, *collé* and *martelé* further augment a student's abilities. In *collé* and *martelé*, emphasis is on defining the function of the bow grip at the extreme ends of the bow, encouraging awareness of how the viola strings respond, and developing relaxation in the alternation of bursts and releases of physical effort. Mastery of these four strokes will enormously improve clarity, refinement, and energy in sound.

Détaché

The *détaché* stroke, at its most characteristic, is a motoric stroke used in sixteenth-note passage work. The second *étude* of Kreutzer is a familiar example of this “meat and potatoes” stroke, important for all levels of ability.

The *détaché* stroke should have an open and free sound. At first, students may have unnecessary habits when playing *détaché*. Just the word *détaché* can be confusing. For instance, students may stop the bow between strokes (a habit that stresses the muscle connections of the elbow) or may suspend their arm weight between strokes (a habit that stresses the shoulder, neck, and back muscles). Both of these habits produce an unwanted accent in the sound when the bow re-enters the string. On the other hand, when arm weight is kept in the string, an articulate, characteristic “chiff” sound is produced as the bow changes direction, and there is less physical stress. Here is a good place to start: students should learn to keep arm weight in the stroke while the bow is moving and to keep the bow moving throughout the stroke. To keep the bow moving, students should “open” and “close” the elbow joint. To keep the weight into the string, encourage a heavy-arm feeling, with the arm moving side to side along the horizontal plane, and a floppy “chicken wing” feeling, where the upper arm is tossed up and down from the shoulder, along the vertical plane. In string crossings, a combination of these horizontal and vertical movements translates into a circular motion.

After a student is comfortable getting weight into the string, the next step is to even out the sound. A typical student problem is playing the downbow stroke louder and longer than the upbow stroke. If students seem unaware of the resulting heavy

Reach for the stars!

NEW!
STELLAR™

Our newest brand name bowed instrument strings! The full core, chromium steel-wound quality craftsmanship produces a rich and distinctive sound.

ALL OUR PRODUCTS MADE IN U.S.A.



SENSICORE®

Synlon® core, aluminum, nickel, silver, tungsten, or silver/tungsten-wound. Also, Viola daGamba



SUPREME®

Rope core, multi-stranded, nickel, silver, or tungsten-wound.



PINNACLE®

NEW! Chromium alloy over rope core.



RED LABEL®

Full core, nickel-wound.



Also ask your music dealer about all our other bowed instrument accessories or write for our free catalog
SUPER-SENSITIVE MUSICAL STRING CO. • 1805 APEX RD. SARASOTA, FL 34240-9386 U.S.A.

"Over 65 Years of Musical Product Excellence"

downbeats and shortchanged upbeats, record them on a reel-to-reel tape recorder, and then play the tape back to them at half speed. This will give them the opportunity to hear objectively. To remedy this uneven stroke, emphasize weight and motion in the upbow stroke, pointing out the feeling of centrifugal force across the body (very much like the follow-through in a tennis forehand stroke). At the same time, encourage relaxation in the down-bow stroke—just letting gravity do the work. Students should pay careful attention to the bow change going from upbow to downbow, making sure that the motion is full and relaxed, not rushed and jerky.

When shaping the line in études and repertoire using the détaché stroke, vary the amount or speed of the bow—more bow for forte, less bow for piano. It is important not to change the soundpoint (proximity of bow to bridge) or weight excessively during a single stroke; these changes should take place over the course of several notes and strokes. Otherwise, the color of the sound changes drastically, breaking up the line rather than

shaping it. Gradually vary the soundpoint and weight to achieve a tenacious, carved-out line. Keep the soundpoint and weight consistent while changing bow speed to promote a healthy, even sound. An extra benefit of this consistency is that it discourages rushing during crescendi (by adding bow, allowing the arm a larger motion) and dragging in diminuendi (by decreasing amount of bow, giving the arm a smaller motion).

These issues in détaché are important not only at the beginning stages of learning, but relevant to all levels of study. Helpful études are Mazas no. 21, Bruni no. 1, and Kreutzer nos. 2, 5, and 8. If, in your teaching, you need easy pieces with many opportunities for détaché, try Hoffmann.

Legato

The legato stroke is used for singing passages such as the opening viola solo of the second movement of Mozart's Sinfonia Concertante. The stroke may involve any combination of note values, played either under a slur or separately. Smooth, connected

bow changes are very beautiful, enhancing the singing quality of a musical line. Sustaining power is needed for a line to soar. These qualities of smoothness and support are analogous to a singer's breath control.

Many of the same issues associated with *détaché* carry over to *legato*. For example, keeping the arm weight and motion consistent through bow changes is important—but now also at the extreme ends of the bow, frog and tip. Open strings are great for this kind of work, and, for a challenge, use open-string double stops. Point out to students the sense of resistance in the weight of the bow on the string to produce that rich, “into the string” quality. One of the special problems associated with this stroke is an unwanted bounce in the middle of the bow, the “bobble,” which occurs from an unnecessary and stressful suspension of arm weight as the bow reaches the area just above the middle—the forearm muscles are not relaxed and the elbow joint is a bit locked. To alleviate the bobble, encourage students to keep the elbow joint moving smoothly and gently (reducing stress on the muscle connections at the elbow) while dropping the arm weight into the string.

Other problems with the full-bow *legato* stroke include changing bow direction before reaching the frog. Teach students to lift the weight of the arm, from the elbow up, for the last few inches of bow using a combination of upper arm, pectoral, and back muscles, (in a slower version of the vertical “chicken wing” used in *détaché*). Of course, just the arm should go up and down, not the shoulder.

A *legato* stroke does not always use the entire length of the bow. Working on bow changes in the lower half, the upper half, and the middle, as well as at the extreme ends of the bow, is important—especially for pieces such as Bach's unaccompanied cello suites, where bow distribution is a primary artistic concern. When shaping the line, change the soundpoint, speed, and weight gradually within the stroke so as not to interrupt the line, but rather to enhance it. As with *détaché*, it is especially important in the *legato* stroke to keep the bow into the string during bow changes and to keep the soundpoint consistent during string crossings (whether near the bridge or over the fingerboard). When

making dynamic changes in *legato*, unlike *détaché*, bear in mind this paradox: sometimes more bow is used in piano passages (less resistance, for a more airy sound), and less bow in forte passages (more resistance, for a more solid sound). Slow scales, slow melodic études (such as Mazas *Études Spéciales* nos. 5, 7, and 18, Dont, op. 37, nos. 1 and 5, and Kreutzer no. 14), slow movements of classical concerti, and short character pieces for the Romantic era are perfect repertoire for developing the vocal quality of *legato*.

Collé

Collé is only rarely used by itself in the repertoire—but is often used as a component of other strokes. In the few occasions where it is used by itself, it appears characteristically as a rhythmically heavy, clearly articulated, lifting upbeat. The swaggering eighth-note upbeat in the *Gigue* of Bach's D minor solo cello suite is a prime example. This is an ideal stroke for addressing problems of the bow hold and the small muscle coordination of the bow arm. Kreutzer's étude no. 7, the classic étude for the study of this stroke, develops the coordination of energy and release in the bow hand and leads to a clear aural and tactile sense of how notes begin and end—an awareness of how the strings respond. After practicing *collé*, students are less likely to force the sound; thanks to the small detailed motion of the fingers they are better able to get into the string to articulate immediately and clearly. This technique leads to the ability to control tone quality over a wide range of gestures, from tiny, delicate attacks and releases to larger, dramatic attacks and releases.

After so much work with large muscle groups in the *détaché* and *legato* strokes, *collé* is a nice change, emphasizing smaller motions and a different group of muscles. Played near the frog, *collé* is a highly energetic stroke that articulates on the string and follows through off the string. The player “catches” the string, making a delicate “chiff” articulation, and then follows through off the string to create a ringing sound. It is a difficult stroke, with several opposing finger motions occurring at the same time. The challenge of *collé* is to feel the weight transfer in the bow grip, with



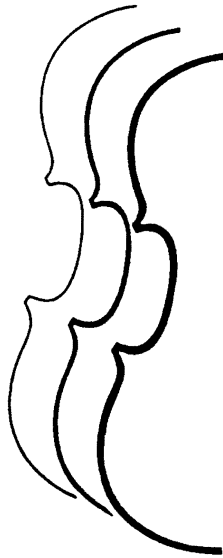

GEOFFREY OVINGTON

MAKER OF VIOLINS,
VIOLAS AND CELLI

Instruments of Distinction
Played Internationally

GEOFFREY OVINGTON VIOLINS

STANTON ROAD
SHUSHAN, NY 12873
U.S.A.

518-854-3648

VIENNA PHILHARMONIC (PR. VLA.)
ALBAN BERG STRING QUARTET
DEUTSCHE KAMMERPHILHARMONIE
NEW YORK PHILHARMONIC
JOACHIM-KOECHERT QUARTET

LOS ANGELES CHAMBER ORCHESTRA
BUFFALO PHILHARMONIC
LAFAYETTE QUARTET
BAVARIAN RADIO SYMPHONY (PR. VLA.)
ST. CECILIA CHAMBER ORCHESTRA

OPERA ORCHESTRA OF LA SCALA (PR. VLA.)
OSLO PHILHARMONIC
VIENNA RADIO SYMPHONY
NORWEGIAN CHAMBER ORCHESTRA
GÖTEBORG SYMPHONY

all fingers connected to the bow, with the little finger and ring finger taking active roles, while achieving flexibility, energy, and relaxation of the joints and muscle connections. The goal is to achieve full range of finger motion with a clinging, but not tense, grip.

In preparation for learning this stroke, ask students to put their four fingers on a tabletop with the tips touching the wood at the edge of the table. The entire arm and hand, except for the fingertips, will be suspended in mid-air, parallel to the table. With a flat wrist and arm, the palm gently pushes down so that the fingers are arched above the base joints—the underside of the base joints becomes level with the fingertips and tabletop. Next, the same position of the fingers is achieved without the aid of the table, by flexing the curled fingers up from the base joints. After this, the same thing is done holding a pencil bow-style. At this stage, the thumb gets involved. The exercise works with a straight or bent thumb, because either way the thumb opposes the fingers and also moves from its base joint. Then the bow is put on

the music stand and the student tries to lift just the lower half off with this motion, and finally, tries to push and pull the bow back and forth on the horizontal shelf of the music stand.

The next step is to try *collé* on the viola. In *collé*, usually the downbow stroke is less easily performed than the upbow. This is because in the downbow the fingers must start from a curved, windup position. It is easier to go from up to down than from down to up. The windup occurs at the end of the upbow stroke to prepare for the downbow stroke.

Martelé

The *martelé* stroke is normally used in the upper half of the bow, but can also be used on partial or full bowing, with a feeling of being “pulled” and “pushed.” *Martelé* has great energy. It can be either unsustained, as in the eighth-notes of the second movement of the Telemann Concerto in G, or sustained, as in the introductory half-note motif to the fourth movement of the Brahms F–minor Sonata.

The martelé stroke will be well prepared after working on détaché, legato, and collé. Once these other strokes feel comfortable, and the tone is deep and “into the string,” martelé will be a very helpful stroke for students who want to produce a truly articulate, big, “soloistic” sound. However, this stroke has many pitfalls. Incorrect martelé technique will cause the student to *press* the sound rather than *pull* the sound. If too much dead pressure is applied to the string, the upper harmonics of the string are emphasized (rather than the fundamental), causing an edgy “eeee” sound, as opposed to the more desirable, deep sound of the fundamental “whaahhh.” Another pitfall is the tendency not to relax between strokes. Feeling the difference between the force of energy in the stroke and total relaxation between strokes is very important.

The martelé stroke begins and ends on the string from a stopped position. Like a collé attack, one “catches” the string, but then follows through on the string with a quick motion. A concept called “active and reactive motion” comes into play in high energy strokes such as martelé. When the violist pulls a martelé stroke with great energy, it is important that the body react to the energy, not tense up against it. The arm pulls actively while the body relaxes and moves reactively. This helps create an energized sound without a forced character. To feel total relaxation between strokes and their corresponding bursts of energy, work on one stroke at a time, relaxing completely for several seconds between each stroke. There will be a clear, articulate attack, with a round, ringing follow-through. It is helpful to practice both a martelé stroke that starts fast and ends slow, as well as the opposite, a stroke that starts slow and ends fast; musically and physically these are very different experiences. Useful

études include Mazas no. 3 and Kreutzer nos. 4 and 6. This stroke can also be practiced using the same études or pieces as those for détaché and collé. Have students reuse repertoire they have memorized; this allows full concentration on the sound, kinesthetic feeling, and the appearance of the stroke (in a mirror).

The above ideas are so much a part of mainstream teaching these days, I can hardly make a claim to originality. However, as teachers we learn afresh these and many other ideas every day.

Note

Many people have influenced my work and it would be impossible to give them all credit here. I would like to thank all my students, and my teachers, especially violists Masao Kawasaki and Karen Tuttle, and colleagues, violinists Eliot Chapo, Karen Clarke, Julian Ross, and conductor David Hoose. My most sincere thanks go to composer David Denniston and violist Melissa Brewer who helped me a great deal with writing this article. I am also grateful to violist Jeffrey Irvine, editor of this Viola Pedagogy forum, for his excellent suggestions for this article, and to violist and *JAVS* editor David Dalton.

Violist Pamela Ryan has been praised for her “delicious, dark tone” (Tallahassee Democrat) and for “remarkable technique and musicianship” (American Record Guide). She is currently associate professor of viola at Florida State University in Tallahassee, Florida; principal violist of the Tallahassee symphony; and a faculty artist at the Yellow Barn Chamber Music Festival in Putney, Vermont. She is on the executive board of the American Viola Society and is former president of the Florida American String Teachers Association.

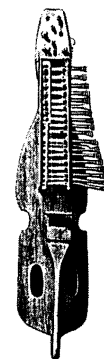

MOES & MOES

VIOLIN MAKERS



**New Instruments
made by
Peter & Wendela Moes**

Sound Adjustments
(by appointment)

New Address:

134 Brooksdale Road
Stamford, CT 06903

Phone (203) 461-9560

FAX (203) 461-9562

e-mail: moes@connix.com
www.chamfer.com/moes

JOHN- BRASIL

The NAME in
QUALITY PERNAMBUCO
WOODS and BOWS

1993
45 LOBBY EXHIBITIONS
INTERNATIONAL
ON 5 CONTINENTS

Horst John & Cia. Ltda
Box 606 - Rio de Janeiro
BRAZIL

Reference:
Bischofberger Violins
1314 East John
Seattle, WA 98102
Tel: (206) 324-3119

DEALERS, MUSICIANS, COLLECTORS, MAKERS ...

Specialized Insurance Coverage for the Classical & Vintage Musical Instrument Trade

- The most comprehensive protection at reasonable cost.
- Underwritten by a financially sound A-rated company.
- Call Toll Free today for information and quotation.

ELLIS W. HERSHMAN
Heritage Insurance Services, Inc.
826 Bustleton Pike, Suite 203
Feasterville, PA 19053

800-289-8837

FAX: 215-322-5854



BEYOND BRAHMS: TWENTIETH-CENTURY REPERTOIRE FOR MEZZO (ALTO) WITH VIOLA

by Sheila M. Allen

When one first considers repertoire for alto voice with viola, little beyond Brahms's *Geistliche Lieder* comes to mind. Even though original literature for viola has been written continuously since 1700,¹ the instrument is rarely regarded as a partner to vocal chamber music, despite its noble, rich tone. Therefore, it is eye-opening to discover twenty pages of repertoire for voice and viola, by themselves and in combination with other instruments, in Franz Zeyringer's repertoire source book, *Literatur für Viola*. Here compositions are listed for all voice types, in several languages, ranging in stylistic period from the Baroque to the present. Although many of Zeyringer's entries exist only in manuscript form or are presently out of print, the music library of violist Rudolf Nel and his wife, contralto Lore Fischer, represents a valuable repository of this repertoire. Their collection contains not only the majority of the catalogued repertoire, but several uncatalogued compositions as well. In the course of their extensive careers, they amassed and performed a wealth of music beyond Brahms's admired lieder.

Born in Stuttgart in 1908, contralto Lore Fischer grew up in a home with much music-making and singing, although no one in the family was a professional musician. At the age of seven, she began twelve years of violin study, including weekly reading sessions of string quartets—a practice she later credited for her ear-training and reading ability. During several years of vocal study in which she was allowed to sing only exercises, the violin became the voice she used to learn and sing the Schubert lieder and Bach arias she loved. She sang her first *St. Matthew Passion* at the age of twenty-three and presented her first *Liederabend* 13 February 1932, in Stuttgart, with Konwitschny at the piano. In 1933, when the alto originally engaged for the thirty-third Bach Festival in Cologne canceled, the

unknown Lore Fischer, upon recommendation of her teacher Maria Phillippi, stepped in with only three-days' notice.

Accolades and an increasingly active concert and recital career followed, contributing to her selection in 1936 as the first recipient of the Berlin Music Prize. In addition to her performances throughout Germany, she appeared in Switzerland, France, Belgium, Holland, Sweden, Denmark, Romania, and Bulgaria. Her diaries reveal both a sharp self-criticism and a single-minded dedication to her art; she sang and later taught around the world, often under circumstances that would have deterred a less tenacious person.

Rudolf Nel, also born in 1908, came from a family of Dutch musicians. He studied viola with Havemann and Willy Hess at the Hochschule für Musik in Berlin and was also a private student of Carl Flesch. At the age of nineteen he became first violist of the Berlin Philharmonic under Bruno Walter. Following this initial success, he held positions as first violist at the Bayreuth Wagnerfestspiele under Wilhelm Furtwängler, Arturo Toscanini, and Richard Strauß, and with the Bayerische Rundfunk Symphonie under Eugen Jochum and Raphael Kubelik. In addition, Nel was a founding member of the Breronel Quartet, which won the Berlin Music Prize, and taught at the Darmstadt Festwochen für Moderne Musik. Like his wife, he was dedicated to performing and teaching—always in demand for private lessons, master classes throughout Europe and in Japan, and as a juror for major international competitions.

These two extraordinary musicians met in the summer of 1942 at a spa where each had gone to recuperate and prepare for the rigors of the next concert season. Within a week they were engaged and planning programs for the Lore Fischer Trio, which they would form with composer-pianist Hermann Reutter. Nel and Fischer married in November 1942, in

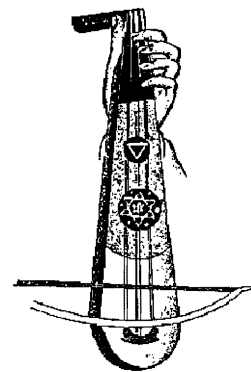



MUSIC PUBLISHERS

RBP is pleased to announce a unique new line of exceptional arrangements for viola, transcribed and edited by ROBERT BRIDGES. This collection has been thoughtfully crafted to fully exploit the special strengths and sonorities of the viola. We're confident these arrangements will be effective and useful additions to any violist's recital library.

1001 Biber Passacaglia (violin)	\$ 5.75
1002 Beethoven Sonata op.5 #2 (cello)	\$ 9.25
1003 Debussy Rhapsody (saxophone)	\$14.25
1004 Franck Sonata (violin)	\$10.75
1005 Telemann Solo Suite (gamba)	\$ 6.75
1006 Stravinsky Suite for Vla and piano	\$28.00
1007 Prokofiev "Cinderella" Suite for Viola and Harp	\$25.00

Include \$1.50/item for shipping and handling

*To order, send your check or money order to:

send for
our FREE
catalogue!

RBP Music Publishers
2615 Waugh Dr., Suite 198
Houston, Texas 77006

IRA B. KRAEMER & Co.

Fine Violins, Violas, Cellos and Bows
Expert Repairs, Restorations, Appraisals
and Accessories

Est. 1967

A selection of Violas for the well advanced student and professional player. Hand made from the finest materials and expertly adjusted in our shop.

Also featuring the violas of the master viola maker Otto Erdesz which are available in limited quantities.

467 Grant Avenue
Scotch Plains, New Jersey 07076

Ph. (908) 322-4469 Fax: (908) 322-8613

Bernard Zaslav chooses:



"My personal preferences for exceptional beauty of tone and playability — violas by JB Guadagnini 1781 Turin, the 'ex-Villa,' and Anthony Lane 1996 Petaluma."

Bernard Zaslav – Stanford, CA 1996

Anthony Lane

Maker of Violins,
Violas, Cellos

276 Liberty Road, Petaluma, CA 94952 USA Tel/Fax 707-795-5929

the Stuttgart church where Fischer had first heard the *St. Matthew Passion* as a child; Gunther Ramin played the organ and Otto Jochum, brother of orchestral conductor Eugen, conducted the choir for the service. For almost fifty years the couple shared their lives and their love of music.

In addition to their separate, on-going solo and teaching careers, they performed countless trio concerts throughout Europe, bringing to the fore compositions created for the combination of voice and viola and eliciting numerous new works. Many of these new compositions were dedicated to them.

The scores, recorded performance dates, and dedications contained in their music library provide a picture of intertwined family and artistic lives as well as a window on the musical and societal trends in Germany from 1942 to 1970. Texts for the vocal works range from Hebbel, Eichendorff, Hesse, and Trakl, to the diary of an anonymous soldier killed in World War II. Compositions, many of them substantial works, were dedicated to the pair in celebration of specific family events: their marriage, the births of their two children, Nel's birthday, their twenty-fifth anniversary. Nel himself composed a piece based on the sayings of their son and arranged lullabies and Christmas carols for alto and viola for family music-making. These were no mere diversions; marginal notations on the manuscripts show that many were performed in concerts or recorded for radio broadcast.

The Nel-Fischer collection contains twenty-six verifiable dedications. Many other scores were autographed and presented to the couple as gifts. Since Fischer carefully inscribed the title pages of her music with date, place, and conductor of her performances, the collection provides a fascinating view of her career. Her copy of Bach's *Weihnachtsoratorium* is inscribed with a record of 119 performances across Europe, spanning the years from 1932 to 1962.

In the mid-1960s *Kammersängerin* Fischer was appointed professor of voice at the Stuttgart Hochschule für Musik. Nel continued in his position as solo violist with the Bayrische



dampit®

Pat No 3 407 700

**the sensational
humidifier for**
VIOLIN ● VIOLA ● CELLO ● BASS

GUARNERI QUARTET

We recommend the Dampit enthusiastically.

dampit provides perfect protection against damage from a dry atmosphere.

dampit proved itself 100% effective in scientific sensor measurements.

FREE Room Humidity Indicator with each **dampit**.

Violin	\$8.95	●	Viola	\$9.50
Little Violin	\$7.95	●	Cello	\$11.50
Bass	\$12.50			

AVOID FAKES, AVOID MISTAKES

A genuine Dampit has the Dampit name on the black top.

Air postage and handling outside USA and Canada \$1.00 per unit.
In USA and Canada please add \$0.65 per unit.
Box 493, Radio City Station, NY, NY 10101

Rundfunk Symphonie and taught and coached in their home near Munich. For over twenty-five years they faithfully traveled to Weimar each summer to teach at the two-week International Musikseminar der DDR (the former German Democratic Republic), trying in musical and personal ways to help aspiring musicians behind the Iron Curtain. They would load their automobile with fruit, sweets, and musical supplies unavailable in the East. Several times they returned home with instruments or other goods purchased simply to help an Eastern Block student.

Past the age of eighty, Fischer continued her travels around the world, adjudicating major competitions and giving master classes in Europe, Japan, and the United States. In a brief autobiography she gave her mother in July of 1944, she had written:

With thankful heart I vow to dedicate my life until my last breath to the beautiful, the good, and the true.²

Bearden Violin Shop

INCORPORATED

DEALERS AND MAKERS
of *Rare and Contemporary*

Violins - Violas - Cellos - Bows

Expert Restorations, Repairs, and Appraisals

Instruments and Bows shipped on approval
with liberal, ten-day trial period

Generous discount on all strings and accessories



Established in and serving the U.S.A. since 1942
Member of Appraisers Association of America &
International Society of Violin and Bow Makers

L. Gene Bearden, President
Gregory Bearden

Call or write for our free brochure
10:00 A.M. – 6:00 P.M., Monday – Friday
9:00 A.M. – 4:00 P.M., Saturday

1-800-929-2327 (314) 427-7570
8787 Lackland St. Louis, MO 63114

This pledge both Nel and Fischer kept until their deaths in 1992.

With the aid of a research grant from Texas Christian University, I visited Germany in the spring of 1995 and traced Andreas Höhrich, the violist who had inherited the Nel–Fischer collection. The collection contains over eighty twentieth-century compositions for voice with viola, original works for voice and string quartet, arrangements by Nel of lieder for voice and string quartet, and many of his continuo realizations of Baroque compositions. Much of the duo and trio music in the collection was stored in leather-covered folders tied together on three sides. Two of the folders contained typed registers of their contents, pasted inside the front covers. Unfortunately, at the time I examined the music, several of the scores listed were missing and others incomplete.

The following catalog comprises the twentieth-century duos for viola and alto and trios for alto, viola, and piano contained in the Nel–Fischer collection. Each entry includes the date of composition (if known), the poetic source of the text, titles of individual songs within sets, overall range, and the number and type of score(s) found in the collection. I have included the dedications, as well as premiere and performance information, not only for their human interest, but as a general indication of performance worthiness. For printed scores in the collection, publication information is provided, and where performance durations appear on the music, these are also included. The voice type specified is a translation of the composer's designation. A few works for soprano are included in instances where markings indicate Fischer performed them. Also included are original works for voice with string quartet and several works for voice and viola with other instruments. Entries preceded by the dagger symbol (†) are of interest but do not strictly fit the parameters of the catalog. In the system used to indicate range, "middle" C = C₄.

This collection of works for voice and viola (as well as Lore Fischer's vast library of solo vocal works, numerous baroque works with continuo realizations by Rudolf Nel, and his arrangements of Liszt, Mussorgsky,

Carleen M. Hutchins

DOYENNE OF AMERICAN VIOLIN MAKERS

—New York Times, June 14, 1994

VIOLAS played in the Cleveland, Billard, Kroll, Laurentian, Shanghai, and Vanbrugh Quartets, and in the symphony orchestras of Boston, Columbus (Principal), Detroit, Edinburgh (Principal) Hamilton, Ontario (Principal), Israel, New Jersey, New York, Newcastle (Principal and second), Northern Illinois (Principal), Portland Oregon (Principal), among others.

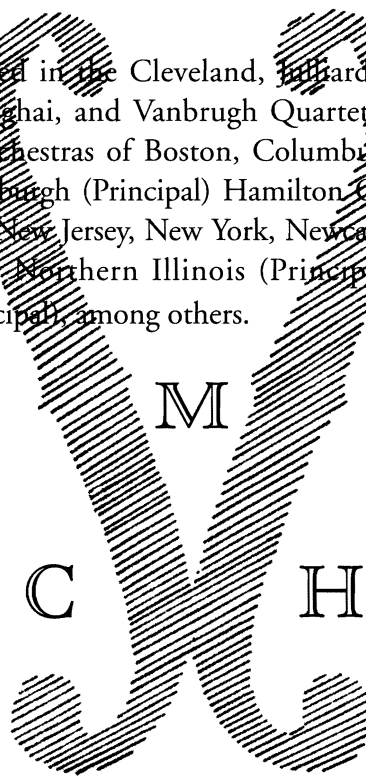

COMMENTS:

"My Hutchins viola creates a sensation wherever I play it. People want to know how to get that tone quality. At the Spoleto Festival they wouldn't believe it."

David Mankovitz, 1962, Kroll Quartet

"Thank you for my marvelous viola."

Simon Aspell, 1992, Vanbrugh Quartet

"Perhaps the most beautiful sounding viola I ever played. I would be proud to own it if I needed one on a regular basis."

Paul Zukofsky, 1994, Concert Violist

112 Essex Avenue
Montclair, NJ 07042

(201) 744-4029
Fax (201) 744-9197



and Schubert songs and others for alto and string quartet) will be housed in the new building of the Staatliche Hochschule für Musik und Darstellende Kunst, Stuttgart, designated "S" in the following catalog. Information on the scores located in Fort Worth, designated "FW," may be obtained from the author. Entries designated "PIVA" are also available through the Primrose International Viola Archive, Harold B. Lee Library, Brigham Young University, Provo, Utah 84602.

Notes

¹Fritz Zeyringer, *The Viola and its Literature* (Hartberg, Austria: Julius Schön-wetter, 1985), p. 54.

²The original reads: "Dankbaren Herzens gelobe ich, mein Leben bis zum letzten Atemzug dem Schönen, dem Guten, dem Wahren zu weihen"; Lore Fischer, untitled manuscript addressed, "Meiner leiber Mutter zum 14. August 1944," in the private collection of Andreas Höhrich, Stuttgart, Germany, p. 16.

Sheila M. Allen, D.M.A., is coordinator of vocal studies and associate professor of voice at Texas Christian University, Fort Worth, Texas. A winner of the Metropolitan Opera national auditions and a national finalist in the NATS Artist Awards, she has been active as a recitalist and as a soloist in contemporary, operatic, and orchestral repertoire. She premiered Steven Albert's "To Wake the Dead," a work she also recorded for CRI, and is presently engaged in editing and performing works from the Nel-Fischer collection.

Dr. Allen holds degrees from the Oberlin Conservatory of Music and the Eastman School of Music and studied as a Fulbright scholar with Lore Fischer in Stuttgart, Germany. Prior to joining the TCU faculty, Dr. Allen taught at Washington State University and State University of New York-Fredonia.

Dr. Allen can be reached at Texas Christian University at the following e-mail address:

Sallen@gamma.is.tcu.edu

Robertson & sons Violin shop INCORPORATED

Fine Quality Instruments and Bows / Repairs / Rentals / Accessories / Sheet Music
FOR ALL YOUR BOWED INSTRUMENT NEEDS

established 1971

Mail Orders Processed Promptly

(505) 889-2999 • (800) 284-6546

3201 Carlisle, NE Albuquerque, New Mexico 87110

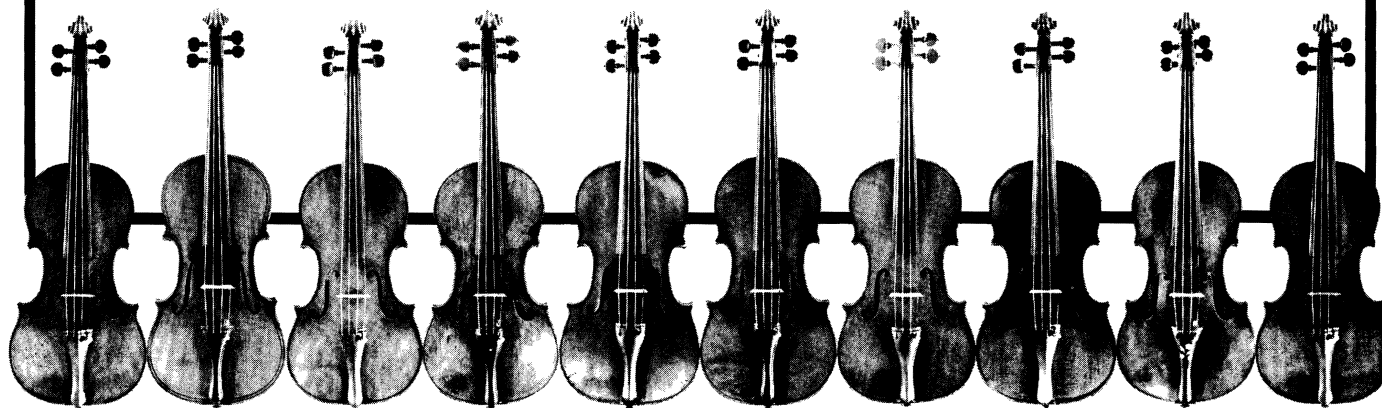

Catalog of the Nel-Fischer Collection

Duos for viola and alto, & trios for alto, viola, and piano

KEY TO CATALOG ENTRIES

COMPOSER (birth–death, nationality or residence)
Title of Work, opus no. / place, year(s) of composition
 Instrumentation / publisher, copyright year
 Text(s)
 Format (handscripted, printed, photocopied, etc.);
 additional publication or descriptive information
 Range / duration / repository (-ies)
 (for repository, S = Stuttgart, FW = Fort Worth,
 PIVA = Primrose International Viola Archive)

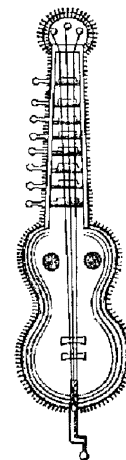

ABENDROTH, WALTER (1896–1973)

Drei Lieder, op. 37 / —

Alto, viola, and piano / —

Poems from the *Ewiger Kalender* of Walter Meckauer:

“Ich fahr durch’s Land,” “Die Sonn tät schlafen
 gehen,” “Hinter dem Hause”

Manuscript: 2 scores, 2 viola parts, 1 small vocal part
 B \flat ₃–F₅ / 8' 30" / S

Meditatives Triptichon, op. 46 / Munich, 1962

Alto and viola / —

Poems by Heimito Doderer: “Die Nacht,” “Votiv-
 spruch vor der Gesichtsmaske Beethovens,”
 “An die Einsamkeit”

Manuscript: 2 copies, 1 dedicated by the composer
 B \flat ₃–F₅ / 8' 10" / S, FW

Pole des Lebens, op. 47 / Munich, 1963

Alto and viola / —

Two poems by Conrad Ferdinand Meyer:

“Der römische Brunnen,” “Fülle”

Dedicated manuscript and vocal part; viola part
 for “Fülle”

B₃–E₅ / 4' 15" / S, FW

BECKENRATH, ALFRED VON (1901–)

Drei Spatzen-Lieder / —

Alto and viola / —

“Spatzenausicht” (F. v. Holzhaufen); “Entrüstung”
 (Grüniger); “Die drei Spatzen” (Christian
 Morgenstern)

Photocopy of a privately published score
 C₄–G₅ / — / S

BORCK, EDMUND VON (1906–1944)

Drei Lieder, op. 23 / Rome, 1943

Alto, viola, and piano / —

Texts by Rainer Maria Rilke: “Mondnacht,”
 “Vorgefühl,” “Einsamkeit”

Two photocopies of original manuscript inscribed
 with many performance dates

A₃–G₅ / 13' 00" / S, FW

BUSCH, ADOLF (1891–1952)

Drei Lieder, op. 3a / —

Voice, viola, and piano / Berlin: Simrock, 1922

“Nun die Schatten dunkeln” (E. Geibel);

“Wonne der Wehmut” (Goethe); “Aus den
 Himmelsaugen droben” (H. Heine)

Manuscript transpositions by Rudolf Nel
 B₃–G₅ (orig.); A \sharp ₃–F₅ (trans.) / 7' 30" /
 S, PIVA; transpositions S, FW

DRAGASTINOWSKI, STEFAN (Bulgarian)

Zwei Lieder / —

Alto and viola; or alto, viola, and piano / —

Biblical texts: “Herr, unser Herrscher,” “Hilf mir,
 O Gott”

Two manuscripts for alto and viola; 2 photocopied
 manuscripts for trio; extensive alterations in parts
 F₃–E₅ (line remains either high or low) /
 14' 30" / S

EBEN, PETER (1929– , Czech)

Písně Nelaskavé (Lieblose Lieder) / 1963

Alto and viola (piano version included) / Prague:
 Panton, 1965

Poems, with German translation by Bedrich Eben:

“Zed’—Die Wand” (Tadeusz Rózewicz);

“Rozchod—Trennung”; “Na příklad—Zum

Beispiel” (Tadeusz Rózewicz); “Kdyz mrtví se

setkáme—Wenn wir uns tot begegnen” (Endre

Ady); “Anno Domini MCMXXI” (Anna Ach-

matová); “Stesk-Sehnsucht” (Vitezslav Nezval)

Manuscript, manuscript copy, printed edition (1965)
 A \flat ₃–G₅ (tess. C₃–E₅) / c. 15' 00" / S, FW, PIVA

EISENMANN, WILL (1906– , Swiss)

Sänge eines fahrenden Spielmanns, op. 56 / Luzern:
 1954

Alto, viola, and piano / —

Poems by Stefan Georg: “Aus den Knospen,” “Sieh
 mein Kind ich gehe,” “Ist es neu dir was vermocht,”
 “Ein Edelkind sah vom Balkon,” “Das Lied des

Lawrence Furse Violas

- * *Patterned after the Brescians using the most desirable models*
- * *Body and string length set for ease of playing*
- * *Top quality tonewoods employed*
- * *Artistically created and varnished in the appearance of antiquity*
- * *Each instrument double purfled with fleur de lys inlay*
- * *Quality for the professional, yet realistically priced for the student*
- * *Each instrument individually handcrafted*
- * *Over 20 years experience*

Honest Craftsmanship

Lawrence Furse, Viola Maker
9400 Emigration Canyon
Salt Lake City, Utah 84108
(801) 581-9225

Zwergen I," "Das Lied des Zwergen II," "Das Lied des Zwergen III," "Erwachen der Braut," "So ich traurig bin . . ."

Dedicated manuscript: "Lore Fischer und Rudolf Nel freundschaftlichst zugeeignet"; premiere 15 Sept. 1955, Rundfunk München; other dates
B \flat ₃-F₅ / 11' 30" / S, FW

ELLING, HANS

Drei Lieder westfälischer Dichter / —

Low woman's voice and viola / —

"Mein Schritt ist schwer" (Carl Böhmers)*; "Der Buchenbaum" (Karl Ernst Homringhausen)*; "Hoffnung" (Franz Anton Joseph von Sonnenberg)*; additionally, *Zwei Lieder*: "Wiegenlied"* and "Neues Jahr" (texts by Hans Sakautzky)

Private printing by München Notenvervielfältigung, Jos. Hochwind

G₃-E₅ / B \flat ₃-D₅ / 6' 00" / S, *FW

FORTNER, WOLFGANG (1907-1987)

Aria / 1950

Mezzosoprano, flute, viola, and piano (Mezzo, viola & chamber orchestra) / Mainz: B. Schott's Söhne (# 38090)

Text by T. S. Eliot from "Mord im Dom," translation by Rudolf Alexander Schröder, (Opening of Act II)

Dedicated manuscript: Christmas, 1950; professionally handcopied score, 1951

B₃-G \sharp ₅ / S, FW

GANS, JOSÉ MORENO (Spanish)

Cinco canciones españolas / Madrid, 1960

Alto, viola, and piano / —

"Mi Lira," "Desden," "El columpio," "Para Eugenia" (Nana), "Castro-Urdiales" (text R. Alberti)

Two dedicated manuscripts: "Para el Trio Lore

Fischer, como recuerdo de unas horas muy felices"; also a letter from Siliva Ras (composer's widow)

C \sharp ₃-E₅(G₅) / 9' 00" / S, FW

GERSTER, OTTMAR (1897-1969)

Vier alte Lieder / 1940

Alto and viola / Mainz: B. Schott's Söhne

(# 3796), 1953

Unknown poets: "Kein Freud ohn dich," "Ich kann und mag nicht fröhlich sein," "Liebhaben und selten sehn," "Wenn ich des morgens früh aufsteh"

Two copies of published edition; performance dates

C₄-E \flat ₅(F₅) / 7' 50" / S, FW

HAENTJES, WERNER (1923-)

(VII) Serenade / 1950

Alto, viola, and piano / —

Text by Rodolfo del Braccio (1508-?)

Two manuscripts and 3 handcopies

C \sharp ₄-F \sharp ₅ / — / S, FW

Ein Wiegenlied beim Mondenschein zu singen /

Cologne, 3.X.53

Alto and viola

Text by Matthias Claudius

Dedicated manuscript: "Für Kristina Otilie Nel zum 26.IX.53"; handcopy (R.N.)

C \sharp ₄-E₅ / 2' 20" / S, FW

Vier Lieder nach andalusisch-maurischen Texten /

Cologne, 1958

Alto and viola / —

German paraphrases by Janheinz Jahn: "Zwei Freunde nur," "Dies Land," "Die Narzisse," "Mein Liebster"

Dedicated manuscript: "Meinem lieben väterlichen Freund Rudolf"

Nel zum 50. Geburtstag"; handcopy (R.N.)

B \flat ₃-E₅ / 7' 35" / S, FW

Sechs alte deutsche Weihnachtslieder / Cologne, 1953

Arrangements for alto, viola, and cembalo / —

"Ave Maria," "Maria durch ein Dornwald ging,"

"Uns ist geboren ein Kindelein," "Wach Nachtigall, wach auf," "O Jesulein zart," "Fröhlich soll mein Herze"

Dedicated manuscript; handcopy of viola part

B \flat ₃-D₅ / 8' 00" / S, FW

Ave Maria, with "Herzliche Liebe" / 1969

Alto, viola, and organ / —

Latin text for *Ave Maria*; "Herzliche Liebe" by Hermann Claudius

Manuscript, handcopy, letter from the composer
G \sharp ₃-D₅, B \flat ₃-C \sharp ₅ / *Ave Maria* 4' 30" / S, FW

HALLER, PETER (1929–)

Requiem / 1945, 1949, 1962

Alto and viola / Stuttgart: Hänssler Verlag

(Die Kantate series # 181), 1964

Text by Friedrich Hebbel: "Seele, vergiß nicht die Toten"

Dedicated manuscript (1945); revision manuscript (1949); handcopy of '49 (R.N.); published edition dedicated "Lore Fischer und Rudolf Nel in Dankbarkeit"

C₄-B₄ / 6' 00" / S, FW, Hänssler available

HARTMANN, ARTUR (1893–)

O schönsten Lied / Dresden, 1947

Alto and viola / —

Text by Hanna Berthold

Two manuscripts

G₃-F₅ / 41 measures, "Gemessen" / S, FW

November / Freiburg, 1955

Alto and viola

Text by Artur Hartmann

Manuscript

B^b₃-D₅ / 17 mm., "Langsam" / S, FW

HAUSEGGER, SIEGMUND VON (1872–1948)

Drei Gesänge nach mittelhochdeutschen Dichtungen / 1927

Medium female voice, viola, and piano / Berlin: Ries & Erler

"Liebesklage" (Volkslied from the 13th century); "Der Falke" (Der von Kürenberg); "Liebeslied" (13th century)

Two copies of Ries & Erler edition; handcopy of viola part; transposition one step lower of "Liebeslied"

C₄-G₅ / 11' 10" / S, FW

HAY, FRED (Frederich Charles, 1888–1945, Swiss)

Vier Lieder, op. 20 [op. 21 overwritten & printed in Zeyringer] / 1930

Soprano, viola, and piano / Bern: Mueller & Schade Kommissionsverlag

"Herbstbild" (Fr. Hebbel); "Ich und Du" (Hebbel); "Nachglanz" (Dehmel); "Schifferliedchen" (G. Keller)

Transposition intervals written in score, but no transpositions were found

— / — / S

HERBERGER, ROLF (1908–)

Schwedische Lieder / 1967

Alto, viola, and piano / —

"Der Fluß," "Schärenfahrt," "Überm See," "Am See," "Winter"

Manuscript: viola and voice parts; piano score missing; evidently performed often (the viola part is heavily marked)

F₃-D₅ / — / S



Music for Three

Two volumes of familiar favorites from the Baroque, Classical, and Romantic Periods - Each volume contains 35 arrangements!

Ideal for * Weddings * Parties * Churches * Workshops * Just Plain Fun

* *Optional Keyboard/Guitar Part* * *Spiral Binding*

* *Interchangeable Parts* * *Matching Page Numbers*

These arrangements have been designed to be played by the following instruments:

** Part 1 Flute or Oboe or Violin

* Part 2 Flute or Oboe or Violin

** Part 2 Viola (in alto clef)

* Part 2 Clarinet (in Bb)

** Part 3 Bassoon or Cello

* Keyboard/Guitar (with chord symbols)



RESORT PRODUCTIONS

(800) 648-4042, or Fax (818) 766-9945

11288 Ventura Blvd. # 820, Studio City, CA 91604

Visa/Mastercard accepted resortprod@earthlink.net

Drei Lieder / 1960

Alto, viola, and piano / —

Texts by Georg Trakl: "Im roten Laubwerk voll Gitarren," "Der Schlaf," "Im Park"

Two photocopied manuscripts; handcopies of voice and viola parts

F[#]₃-F₅ / — / S, FW

HLOUSCHEK, THEODOR

Fünf Gesänge nach altchinesischen Texten / 1959

Alto, viola, and piano / —

Texts from *Die chinesische Flöte* by Hans Bethge:

"In Erwartung des Freundes," "Die Einsame,"

"Die Lotosblumen," "Nächtliches Bild,"

"Mond und Menschen"

Manuscript score; voice and viola parts

B₃-F[#]₅ / — / S

Ein Liederzyklus nach Texten von IPF / 1961

Alto and viola / —

"Schlaraffenland," "Macht der Persönlichkeit,"

"Stoß-Seufzer," "Trost," "Auf dem Pfad der Tugend,"

"Eisenbahn"

Two manuscripts, one with changes in the viola part made by R.N.

(G)A₃-E^b₅(F[#]₅) / 8' 00" / S, FW

Des Mädchens Klage / 1962

Alto, viola, and piano / —

Texts from the *Schi-King* paraphrased in German by Hans Bethge: "Freund, ich beschwöre dich," "Verzweiflung," "Das traurige Herz"

Manuscript score; voice and viola parts
 B^b_3 - G_5 / — / S

JOCHUM, OTTO (1898-1969)

Blütenzweige vom Mondnachtbaum, op. 104;
*Sieben Lieder der Sehnsucht nach japanischen
 Texten* / 1951

Alto, 2 flutes, and viola (with piano reduction) / —
 Japanese texts recast by Paul Lüth: "Liebes-
 versprechung," "Sehnsuchtslied," "Der Mond,"
 "Mit einem Blütenzweige," "Ungewißheit,"
 "Zuversicht"

Manuscript score and all parts; privately printed
 score with piano reduction
 A^b_3 - F_5 / 8' 30" / S, FW

Gesänge an die Nacht, op. 83 / —

Medium voice, viola, and piano / Augsburg: Anton
 Böhm und Sohn 1947

Poems by Arthur Maximilian Miller and Rudolf
 Hägni: "Abendhimmel" (M); "In ihrem Nahen"
 (M, after the Rigveda); "Im tiefen Walde" (M);
 "Mondnacht" (H); "Die Nacht ist groß" (H)

Two copies of 1947 edition, dedicated "Lore Fischer
 und Rudolf Nel zu eigen"; 2 handcopies of score
 and viola part for "Die Nacht ist groß," trans-
 posed down one step
 (G) B^b_3 - G^{\sharp}_5 (A_5) / 24' 00" / S, FW

KAMMEIER, HANS

Drei Morgenstern-Lieder / 1969

Alto and viola / —

Poems by Christian Morgenstern: "Lunovis, das
 Mondschaft," "Igel und Agel," "Der Tanz"

Manuscript; photocopy
 G_3 - E^b_5 / 10' 25" / S, FW

KNAB, ARMIN (1881-1951)

*Rosa mystica. Sechs Sinnsprüche des Angelus
 Silesius* / 1949

Alto and viola / Mainz: B. Schott's Söhne
 (#3879)

Texts by Angelus Silesius

Photocopied manuscript with the dedication "Dem
 Künstlerpaar Fischer-Nel in herzlicher
 Verehrung"; two handcopied scores, viola part;
 two copies of published edition, one inscribed
 "Lore Fischer und Rudolf Nel in herzlicher
 Dankbarkeit"

(G_3) A^b_3 - E^b_5 / 8' 00" / S, FW

KOCHER-KLEIN, HILDE (1894-)

Fünf Tanzlieder des Neidhart von Reuental,
 op. 96 / —

Alto, viola, and cembalo / —

Poems by Neidhart von Reuental: "Horch auf,"
 "Alles was den Sommer her in Freuden war,"
 "Maienzeit, bannet Leid," "Blumen und auch
 Klee"

Dedicated manuscript; professional handcopy,

(1958); handcopied viola part
 G_3 - F_5 (tess. C_4 - D_5) / — / S, FW

O Liebe du (Ein Liederkreis nach sieben Gedichten
 von Hans Heinrich Ehrler), op. 75 / —
 Alto, viola, and piano / —

Poems by Hans Heinrich Ehrler: "O Liebe du,"
 "Wie bist du schön," "Da und dort," "Geliebte,
 ein Wort in der Wind," "Du ruft mich an,"
 "Es hat der Himmel mit den Sternen," "Ja, über
 Tod und Dunkel"

Dedicated manuscript with performance dates; one
 photocopy; handcopy of viola part; premiere
 27 Feb. 1957

A_3 - F_5 / 13' 50" / S, FW

Zwei Lieder der Stille (Christof vorgesungen von
 seinen Eltern) / 1953

Alto and viola / —

"Wiegenlied" (Brentano); "Schlaf ein" (Schauman)

Dedicated manuscript with performance dates;
 handcopy

G_3 - E^b_5 / 3' 50" / S

Vier geistliche Gesänge, op. 104 / —

Alto and viola / —

Texts by Mechtild von Magdeburg (1308):

"Introitus—Erwartung," "Alter pars—
 Der Weg," "Medium mysticum—Vereinigung,"
 "Hymnus—Lobgesang"

Two dedicated manuscripts with performance dates
 G_3 - F_5 / 8' 30" / S, FW

† *Danklied* / —

Voice and piano / —

Dedicated manuscript "Zum 25. Verlobungstag"
 — / — / S

KOETSIER, JAN (1911- , Dutch)

Anfang und Ende, Gesänge der Nacht, op. 1 /
 1932, 1956

Alto, viola, and piano / revised edition, Amster-
 dam: Donemus, 1956

"Anfang und Ende" (K. B. Capesius); "Nacht,"
 "Mädchen am Fenster," Nocturn I, Nocturn II
 (R. v. Ostau); Schlußstück (Rainer Maria Rilke)

Handcopy of viola and voice parts (by R.N.);
 dedication in viola part

(A) B^b_3 - E_5 (F^{\sharp}_5) / — / S, FW

KÖHLER, WOLFGANG (1923-)

Vier Lieder nach Gedichten von Rilke, op. 2 / —

Alto, viola, and piano / —

Poems by Rainer Maria Rilke: "Der Knabe,"
 "Herbsttag," "Das Lied des Idioten,"
 "Der Tod ist groß"

Manuscript with viola part and handcopied voice
 part; premiere 3 March 1958

A^b_3 - E^b_5 / — / S



KOMMA, KARL MICHAEL (1913–)

Die Sonnenuhr / 1952

Alto, viola, and piano / —

Poems by J. Weinheber: "Der Mensch, so schmal in Zeit und Raum," "Der Zeit entfesseltes Gespann," "Ein Rossepaar im Lauf," "Es meint das Bildwerk," "Es schlägt das Herz," "Der hemmungslosen Zeit"

Photocopy rental manuscript; photocopy; hand-copied viola and vocal parts

(G₃) C₄–E₅ / 16' 00" / S, FW

In den Bergen von Cuscione / 1964

Alto and viola / —

Six Corsican songs in paraphrases by the composer: "Wir sind die Abgesandten," "In den Bergen von Cuscione" (Wiegenlied), "Der Schulze von Corte," Schäferliche Serenade," "O süße Kleine (Wiegenlied)," "Wo keine Katzen sind"

Two photocopied manuscripts; 2 copies of nos. 1–3 (A₃) B₃–C₅ / 9' 30" / S, FW

KRACKE, HANS (1910–)

Gesänge der Nacht / 1964

Alto, viola, and piano / —

Poems by Hermann Hesse: "Nun der Tag mich müd gemacht," "Die Nacht," "Der stille Hof," "Zunachten," "Wohl lieb ich die finstre Nacht"

Dedicated manuscript, "Lore Fischer und Rudolf Nel in herzlichster Dankbarkeit zugeeignet," with performance dates; manuscript; viola part

A₃–D₅ / 10' 40" / S, FW

KURIG, HANS-HERMANN

Dämmerung / —

Alto, viola, and piano / —

Poem by Konrad Schwartz

Two manuscript pages

C₄–D₅ / — / S

LOHSE, FRED (1908–)

Lyrisches Brevier von René Schwachhofer / 1947

Medium voice, oboe, and viola / (Zeyringer lists published edition, Wiesbaden: Breitkopf and Härtel)

Texts by René Schwachhofer: "Spruch für einen Freund," "Einem Dämon," "Dank," "An einen Verschollenen," "Verfallener Park," "Zueignung"

Manuscript score with oboe and viola parts; a program from Gohliser Schlößchen, Friday, 11 Nov. 1955, documents a performance by alto Gerda Schriever, with Lohse at the piano for other works (the poems were read by the poet before the performance)

C₄–G^b₅ / — / S

MARX, JOSEPH (1882–1964)

Durch Einsamkeiten / 1916

Alto, viola, and piano / Wien: Universal-Edition, A.G.



**CLAIRE GIVENS
VIOLINS, INC.**

Dealers, Makers & Restorers of Fine
Violins, Violas, Cellos & Bows.

We are committed to offering the best
violas and viola bows in all price ranges.

*Celebrating Our 20th Anniversary
1977 - 1997*

1004 Marquette Avenue, Suite 205
Minneapolis, Minnesota 55403 USA
(612) 375-0708 or (800) 279-4323
E-Mail: cgivens@ix.netcom.com

Poem by Anton Windgans

C₄–F[#]₅ / — / S, FW (TCU Library)

NEL, RUDOLF (1908–1992)

*Fünf Impressionen über Sprachgestaltungen eines
siebenjährigen Knaben* / 1952

Alto and viola / —

Thoughts of Christof Nel: "Frühling," "Bach im Winter," "Herbst," "Die Mutter," "Der Brunnen"

Manuscript and 1 copy

G₃–C₅ (E^b₅) / 6' 00" / S, FW

RAUCH, JOSEF (1904–)

Binding-Lieder, op. 14 / Munich, 1941

Alto, viola, and piano / —

Eight poems of Rudolf G. Binding: "Für E," "Rosenhag," "Mondnacht," "Maigeschehen," "Meeresmittag," "Garten, aus dem mir Rosen geschickt wurden," "Fest der Wälder," "Lebenstanz"

Two bound, photocopied manuscripts; viola and voice parts copied by R.N.

— / 13' 00" (nos. 1, 4, 5, 7, 8) / S

RETTICH, WILHELM (1892–1988)

Elysium, op. 30 / —

Arrangement for voice, viola, and harp (7 of 20 poems in a cycle originally for mixed a capella choir, alto, baritone, viola, and harp / —

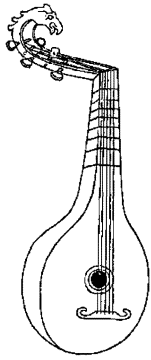

Seven poems by Rudolf Alexander Schröder: "An den Gestaden jenes Flusses," "Das Nicht-Verbunden," "Die im Meer bie den Korallen schlafen," "Wenn ich dich grüßte," "Rede du mir wieder," "Nur mit meines Fingernagels Rande," "Laß, o Fremdling, dieser Worte"

Photocopied manuscript of 7 songs; handcopy of the first 5 by R.N., with nos. 1, 2, and 4 transposed down $\frac{1}{2}$ step

G₃-F#₅ (tessitura: C₄-E₅) / — / S

Fremde Fühlung, op. 107 / —

Alto (bar.), viola, and piano / —

Poems by Friedrich Markus Huebner: "Klopfe-geister," "Erscheinung," "Lebenszeichen," "Auftrag," "Innenwärts," "Diktat," "Geisterhülfe"

Two photocopied manuscripts, one with 8va changes in the voice part; handcopy of score and parts

A₃-F₅ / — / S

REUTTER, HERMANN (1900–1985)

Solo-Kantate, op. 45 / —

Alto, viola, and piano (organ) / Mainz: B. Schott's Söhne (#3853), 1948

Texts by Matthias Claudius: "Die Liebe," "Der Mensch," "Interludium" (piano solo), "Der Sämann," "Choral"

Professional manuscript copy (Jan. 1956) minor-third lower than Schott ed.; Schott ed. contains score with viola part

B₃-F#₅ / 12' 45" / S, FW (alto key)

Fünf antike Oden, op. 57 / —

Alto, viola, and piano / Mainz: B. Schott's Söhne (#3674)

Based on translations of Sappho by Rudolf Bach: "Wie hernieder vom Berge Sturmwind stürzt," "Hinunter ist schon der Mond," "Singet, ihr Mädchen, das Lied," "Seelenlos liegt dereinst da," "Aphrodite! Listreiche Tochter des Zeus!"

Manuscript of voice and viola parts; photocopied manuscript of score; premiere Dec. 1943; 78 performance dates listed (1943–1965)

B \flat ₃-G₅ / 17' 45" / S, Schott available

Kleines geistliches Konzert / 1953

Alto and viola / Mainz: B. Schott's Söhne (#4486)

Based on words by Christian Wagner: "Frage," "Geweihte Nächte," "Ostersamstag," "Großer Feierabend," "Tausendmale"

Printed dedication (Schott ed.) "Lore Fischer in Freundschaft und Verehrung"; photocopied score reduction; manuscript (R.N.) viola part; performance dates from 1953 to 1960, including London, Vienna, Madrid, and radio.

G#₃-F#₅ / 11' 25" / S, FW, PIVA

Concerto grosso "Aus dem Hohelied Salomons" / 1956

Alto, viola, piano, and orchestra / London: Schott (#39483)

From the Song of Solomon: "Er küsse mich," "Ich bin eine Rose im Tal," "Des Nachts auf meinem Lager," "Mein Freund ist mein"

Published score; photocopy manuscript piano score, bound; alto part with 12 performance dates; premiere in Baden-Baden, Hans Rosbaud conducting

A \flat ₃-G \flat ₅ / 30' 45" / S

† *Weihnachtskantilene* / 1952

Middle voice, mixed choir, and piano or organ / Mainz: B. Schott's Söhne (#5903)

Based on words of Matthias Claudius

Schott ed. (#5903) autographed by Reutter; piano/vocal score (Schott #4487) with a printed dedication to Irmgard and Dietrich Fischer-Dieskau; manuscript viola part (probably by R.N.)

— / — / S

ROSELIUS, LUDWIG (1902–)

Geistliche Gesänge, op. 11 / 1950

Low voice, viola, and piano / Berlin: Ries & Erler (R. 9808 E.)

Poems by Eichendorff: "Einsiedler," "Morgendämmerung"

Two copies, one inscribed; no performance markings

A \flat ₃-F#₅ / — / S, FW

RÖSSEL, WILLY

Drei Lieder, op. 12 / —

Voice, viola, and piano / Berlin: Breitkopf & Härtel (E.B. 5235)

"Schließe mir die Augen beide" (T. Storm); "Im Zimmer" (Joh. Schlaf); "Die Hütte" (Paul Reiner)

Breitkopf & Härtel edition; no performance markings

— / — / S

† RÖTSCHER, KONRAD (1910–)

Sechs Lieder nach schottischen Texten, op. 25 / 1952

Soprano, viola, and piano / Berlin-Wiesbaden: Bote & Bock

"Am Yarrow," "Abergeldie," "Zwischenspiel," "Das weiße Heer," "Heimaterde," "Zwischenspiel," "Serenade," "Im grünen Hag"

Two viola parts; markings indicate some of these lieder sung by L.F.

— / — / S, PIVA

SCHADEWITZ, CARL (1887–1945)

Vier Lieder / 1944

Alto and viola / —

"Wie dir geschah" (Justinius Kerner); "Es hallen silberne Glocken" (F. Lienhard); "Schließe mir die Augen beide" (T. Storm); "So komme, was da kommen mag" (Storm)

Dedicated manuscript "für Lore und Rudolf Nel mit herzlichen Grüßen und Wünschen, März, 1944"; copies of nos. 1 and 3; recorded for Radio München in 1956

C₄-F#₅ / c. 5' 00" / S, FW



Steven McCann

Maker of Violas • Violins • Cellos

Available at
Guarneri House
221 John Street NE
Grand Rapids, MI 49503
(616) 451-4960

Weihnachtslieder / —

Arrangements for alto, viola, and piano or organ / —

“Josef bei der Krippe saß,” “Maria ging hinaus,”
“Der Wind auf leeren Straßen,” “Dormi Jesu”
(Latin text)

Manuscript; multiple handcopies; photocopies;
after “Joseph bei der Krippe saß” appears the
remark “folgt: Cembalo-Solo,” but no piano solo
was found

B₃-E₅ / — / S, FW

SCHIBLER, ARMIN (1920–1986, Swiss)

Weil alles erneut sich begibt (cantata), op. 23 / 1949

Low voice, viola, and piano / —

Texts by Werner Bergengruen from “Die verborgene
Frucht” (Zürich: Arche-Verlag, 1947)

Three photocopied manuscripts; viola part with
performance dates; a second “Bergengruen
Kantate” titled *Mondlicht* is a 14-minute com-
position for alto and 2 pianos (the shared label
“Bergengruen Kantate” can lead to confusion
between the two works)

(B₃)C₄-F₅ (A_b^b₅) / 12' 00" / S, FW

SCHLIEPE, ERNST (1893–)

Zwei Gesänge, op. 11 / 1932

Alto, viola, and piano / —

Texts by Willibald Omandowski: “Nacht am Meer,”
“Früher Morgen”

Two photocopied manuscripts with voice and viola
parts

B_b^b₃-G₅ / — / S, FW

SCHREIBER, FRITZ (Friedrich, 1895–1985, New
York City organist, 1939–58)

Drei Lieder, op. 10 / —

Voice, viola, and piano / Wien: Universal-Edition
Texts by Christian Morgenstern: “Vorabendglück,”
“Stör' nicht den Schlaf der liebsten Frau . . .”

“Von zwei Rosen . . .”

Note by R.N., “geb. in Wien 13.I.1895”

A_b^b₃-F₅ / — / S, FW

†**SIEGL, OTTO** (1896–1978, Austrian)

Volkslieder, op. 113 / —

Soprano, viola, and piano / Augsburg: Anton Böhm
& Sohn

“Altes vorarlberger Weihnachtslied,” “Auf dieser
Welt”

Handcopied, transposed viola part (R.N.)

B_b^b₃-G₅ (high tessitura) / 5' 55" / S

†**SIMBRIGER, HEINRICH** (1904–)

Vier Gesänge, op. 41b / Aussig, 28 Aug. 1940

Soprano, viola, and piano / —

Poems of Emil Merker: “Lebenslied,” “Jähes
Erwachen,” “Verirrter Wanderer,” “Abrechnung”

Original manuscript; professional handcopy
(Heinrich Wolfheim, Konstanz, June 1955);
handcopied viola part (R.N.); premiere 1 July
1955, Bayrischer Rundfunk, R.N. and Hans
Altmann (no singer named)

— / — / S, PIVA

SOUCHAY, MARC-ANDRÉ (1906–)

“Willkommen!” *Fragment aus der “Kantate 1943”* / —



The Musician's Mail-Order Choice for
Fine Stringed Instruments and Accessories

COMPLETE LINE OF INSTRUMENTS, BOWS
AND ACCESSORIES

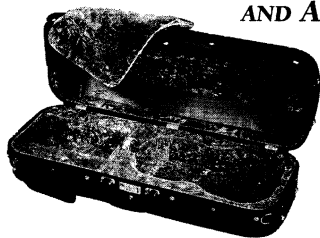

Viola Cases by
J. COPELAND
THE EXCLUSIVE CASE COLLECTION

SHEET MUSIC, EDUCATIONAL
MATERIALS AND MORE IN STOCK

CALL FOR A FREE PRODUCT CATALOG AND
SHEET MUSIC CATALOG

TOLL FREE (800) 528-3430

FAX FREE (800) 528-3470

e-mail sws@swstrings.com

1050 S. Park Avenue, Tucson, AZ 85719

Alto, viola, and piano (range better suited to
soprano) / —

Text freely adapted by Herbert Lange from the
diary of a fallen soldier

Original manuscript and viola part; dedicated "L.
Fischer R. Nel als (leider verspätetes) Hochzeits-
geschenk überreicht vom Komponisten"

E^b₄-A₅ / — / S, FW

STEPHANI, HERMANN (1877-1960)

Einmal werden wir im Lichte wandeln, op. 90, VII /
May 1941

Low voice, viola, and piano / —

Photocopied manuscript; viola incorporated in
piano score

Hymn-like; brief; 4 strophes

C₄-E₅ / — / S

Aus Himmelshallen der Ewigkeit, op. 91, I / Oct 1941

Alto, viola, and piano / —

Two photocopied manuscripts, one large, one
reduced

Hymn-like; brief

B₃-D[#]₅ / — / S

Loblied im Gebirge, op. 94, VIII / —

Alto, viola, and piano / —

Text by Kurt Wiezering, *Vor der Tatra*, 1945

Two photocopied manuscripts

Hymn-like; brief

G[#]₃-E^b₅ / — / S

STRAUß, RICHARD (1864-1949)

Stiller Gang, op. 31, nr. 4 / —

Alto, viola, and piano / Berlin: Adolph Fürstner, 1909
Poem by Richard Dehmel

Manuscript copy transposed down one step (R.N.)

D₄-E₅ (orig.) / — / S, FW

TONETTI, PADRE OTTONE, OFM

Trilogia Petriana / 1958-60

Mezzosoprano, viola, and piano / Padova:

Guglielmo Zanibon

Words of Monsignor Giuseppe del Ton: "Nocturnus
Petrianus Tholus," "Petrianum Horo-
logium," "Petrianus Tholus"

Individual, dedicated manuscripts of each piece
(second section to "Christofore e Christina Nel";
third section to Rudolf Nel; score of trilogy
[Zanibon ed.] with printed dedication "Agli
illustri artisti Rudolf Nel e Lore Fischer e ai loro
figli Christoph e Christine); handcopied viola
part (R.N.).

C₃-F[#]₅ / 12' 15" / manuscripts, S;
published ed., FW

WENZEL, EBERHARD (1896-)

Drei Lieder / 1968

Alto and viola / —

Poems by Albrecht Goes: "Landschaft der Seele,"
"Allerseelentag," "Die Handschrift," "Wer weiß
der Vogel Flug" (fourth Lied evidently sung in
place of third)

Manuscript with third Lied crossed out; two hand-
copies for alto and viola

A₃-F₅ / — / S, FW

Unendlichkeit / —

Alto and viola / —

Text by Albrecht Goes

Manuscript autographed "Mit herzlichen Grüße
und Dank für die Karte, Ihr. . ."

(A₃) C[#]₄-E₅ / — / S, FW

ZEUMER, GERHARD

Drei Lieder / Dec. 1967

Alto, viola, and piano / —

Texts of Hermann Hesse: "Im Nebel," "Kind im
Frühling"; "Bootnacht"

Two photocopied manuscripts

F₃-D₅ / 11' 05" / S, FW

ZOEFEL, KLAUS

Lâ trüren varn (Laß Trübsal fahren) / —

Voice, viola (violin), and piano; (tessitura better for
soprano) / Leipzig: Edition Peters, Collection
Litloff

Mittelhochdeutsche Minnelieder: "Mir entschwand
des Winters Leid," "In lichter Farbe steht der
Wald," "Springtanz," "Die Nachtigall," "Fraue,
meine liebe Fraue," "Ich will Trübsal fahren lan,"
"Erwartung"

Peters edition, a gift from a student at the Inter-
national Music Seminar, Weimar, German

Democratic Republic, July 1964; photocopied score
D₄-G₅ / — / S, FW

AUTHOR UNKNOWN

Drei Lieder / —

Alto, viola, and piano / —

No poet given: "Ein Abend (Schon tritt an die irdischen Ufer)"; "Nacht im Frühling (In die Berge steigt jetzt der Wind)"; "Der Mond (Am Himmels rand, wo nun das Dunkel wohnt)"

Manuscript and viola part (perhaps a handcopy of a missing score)

— / — / S

Compositions with Other Instruments

BRUCKNER, ANTON (1824–1896)

Zwei Gesänge (arranged by Otto Jochum) / —

Alto, with string quartet or organ / Augsburg &

Vienna: Anton Böhm & Sohn

"Ave Maria" (orig. 1882); "Benedictus" (orig. 1841)

Two copies, Böhm ed.

— / — / S

BURKHARD, WILLY (1900–1955, Swiss)

Der Sonntag, op. 63 / —

Medium voice, violin, cello, and piano / Kassel:

Bärenreiter (#2132)

Texts of Jeremias Gotthelf: "Der Sonntag kam am Himmel herauf," "Der tausendstimmige Gesang," "Gott Lob und Dank!"

Bärenreiter score with violin and cello parts

— / — / S

DRESCHER-HAUßEN, KONRAD (1892–)

Vier Gesänge, op. 21 / —

Low voice and string orchestra (or string quartet)

Texts of Wilhelm Kunze: "Wenn das Leben in uns erwacht," "Alles für Dich," "Gestirnte Nacht," "Wie Ströme"

Manuscript, parts, copy of text

— / — / S

EGK, WERNER (1901–1983)

La Tentation de St. Antoine / 1945

Contralto and string quartet / Mainz: B. Schott's

Söhne (# 90), 1947

Thirteen movements based on airs and verses from the 18th century

G₃-F₅ / — / S

MICHEELSEN, HANS FRIEDRICH (1902–1973)

Geistliches Konzert, op. 49 / —

Alto or bass, violin, and organ / Kassel: Bärenreiter (#2146)

Text from 1 Corinthians 13: "Wenn ich mit Menschen- und mit Engelnungen redete"

Score and violin

— / — / S

NEL, RUDOLF (1908–1992)

Vier Lieder / —

Alto and string quartet / —

Texts by Erika Haendler: "Stiller Abend," "Volkslied," "Vor dem Tage," "Zum Tagesende"

Manuscript full score; parts with voice included with first violin

A₃-D₅ / — / —

RETTICH, WILHELM (1892–)

Ich und Du, op. 25 / —

Low voice and string quartet / —

Poems of Christian Morgenstern: "In meinen Tränen," "Auf der Treppe sitzen meine Öhrchen," "Dämmrig blaun im Mondenschimner," "Der Morgen war von dir erfüllt," "Es ist Nacht"

Photocopied manuscript; photocopied manuscript of piano reduction

— / — / S

RÖSSEL, WILLY

Zwei Lieder / 1937

Medium voice, violin, and piano / Leipzig: Breitkopf & Härtel (D.L.V. 5692)

"Vor einem Madonnenbild" (W. Rössel); "Heimweh" (Maria Walter)

Published edition autographed "An Lore, 23.III.38."

— / — / S

THEHOS, ADAM

Sechs Volkslieder / 1949

Arranged for alto and string quartet / —

"Es geht eine dunkle Wolk herein," "All mein Gedanken," "Nun laube Lindlein, laube,"

"Minnelied," "Es wollte sich einschleichen,"

"Ave Maria (Es tönt des Abendglöckleins Schlag)"

Bound manuscript piano score, "Lore Fischer-

Nel gewidmet. Alzey, Rheinhessen im Sommer 1949"

A₃-E₅ / — / S

Ein Strauß Kinderlieder / 1951

Alto and string orchestra (quartet) / —

"Der kleine Geburtstagsgratulant," "Eine kleine Geige," "Der kleine Reiter," "Als der Mond schien helle," "Häschen in der Grube," "Die beiden Hasen," "Beim Bauer"

Bound manuscript piano score, "Der Altistin

Lore Fischer-Nel zur lieblichen Unterhaltung ihres kleinen Christoph in aufrichtiger Verehrung gewidmet. Alzey, Rheinhessen im Frühling 1951."

B₃-E₅ (G₅) / — / S



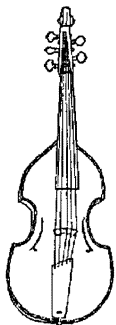

Missing or Incomplete Works

DRAEGER, WALTER

Schifflieder / —

Listed in folder index, score missing; available
through Internationale Musik-Leihbibliothek,
Brunnenstraße 188-190, Berlin N 54

DRESSEL, EDWIN

Drei Sonette von Andreas Gryphius / —

Photocopied manuscript viola part; score missing
— / — / S

HAENTJES, WERNER

Sechs Gesänge nach altspanischen Texten / —

Manuscript viola part; score missing
— / — / S

Am Wasser / —

Manuscript viola part; score missing
— / — / S

HALLER, PETER

Der Kranke / —

Alto, viola, winds, and percussion / —

Text by Hermann Hesse

Photocopied title page, "Lore Fischer und Rudolf
Nel in Dankbarkeit"; score missing
— / — / S

JOCHUM, OTTO

Das [...] / —

Folder's table of contents is torn

†SIEGL, OTTO

Gesänge, op. 112 / —

Soprano, viola, and piano / —

Ina Seidel

Printed viola part; handcopied, transposed viola part
(R.N.); score missing
— / — / S

0.

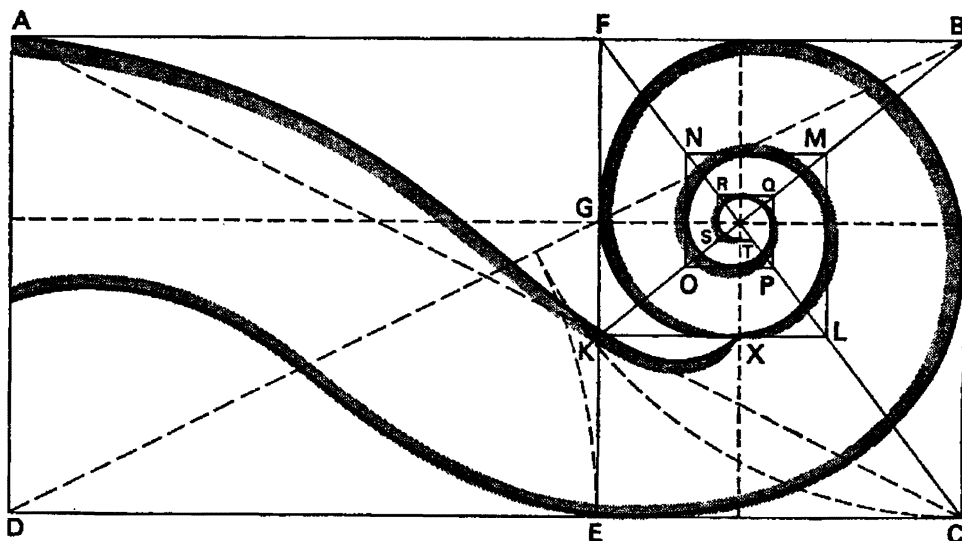

NEW ACQUISITIONS IN PIVA

Editor's Note: This continues the series of installments that will update the holdings of the Primrose International Viola Archive. (PIVA is the official archive of music for the viola of both the International and the American Viola Societies.) Viola scores in PIVA up to 1985 are identified in Franz Zeyringer's Literatur für Viola (Verlag Julius Schönwetter Jun., Hartberg, Austria, 1985), where they are marked with a +. This present series of installments will eventually make the listing current, after which a new acquisitions list will be published annually in JAVS. The entries are listed according to the Zeyringer classification of instrumentation. A future compilation under one cover of all the annual lists is planned as a sequel to the Zeyringer lexicon.

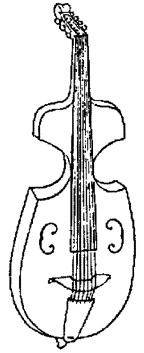

1992 Acquisitions

Viola - Solo

Hurel, Philippe. Altomobile; pour alto seul / Philippe Hurel. Paris: G. Billaudot, 1987.

Kukuck, Felicitas. Die Tänze der Mirjam: für Bratsche allein / Felicitas Kukuck. Kassel: Furore Edition, 1988.

Padilha, Marco César. Triptico: op. 6, für Viola / Marco Padilha. Darmstadt: Tonos, 1987.

Sokolov, Vladimir. Sonata dlja al'ta solo = Sonata for viola solo / V. Sokolov; ed. A.V. Liudeviga = ed. by A. Ludevig. Leningrad: Sov. kompozitor, 1988.

Viola - Solo (arr.)

Bach, Johann Sebastian. The six suites for solo cello: for solo viola / Johann Sebastian Bach; transcribed by Watson Forbes. Boca Raton, Fla.: Masters Music, [1989]

Baryton und Viola

Hamel, Peter Michael. Mittlerer Frühling: sechs Duo-Miniaturen für Viola und Baryton / Peter Michael Hamel. Kassel; New York: Bärenreiter, 1988.

Flöte und Viola

Denisov, Edisson Vasilévich. Duo pour flûte et alto / Edison Denisov. Paris: A. Leduc, 1989.

Violine und Viola

Bruni, Antonio Bartolomeo. Six duos concertants for violin and viola / Antoine-Barthelemy Bruni. Boca Raton, Fla.: Masters Music, [1989]

Lebrun, Ludwig August. Sechs Duos für Violine und Viola, op. 4 / Ludwig August Lebrun; nach dem Erstdruck...hrsg. von Bernhard Päuler; Einrichtung der Stimmen von Franz Beyer. Adliswil-Zürich; New York: Edition Eulenburg, 1974.

Lidl, Andreas. Duetto ex C for violin and viola / Andreas Lidl; edited by T. Donley Thomas. Bellingham, Wash.: Medici Music Press, 1983.

Zwei Violen

Eder de Lastra, Erich. Duo appassionato: 2 Violen / Erich Eder de Lastra. Wien: Doblinger, 1989.

Newman, Michael. Nymphéas rampant / by Michael Newman. [S.l.]: Forward Music, 1988.

Contrabass und Viola

Keyper, Franz Joseph. Rondo solo: for double bass and violoncello or viola / Franz Keyper; [edited by Rodney Slatford]. London: Yorke Edition, 1974.

Klavier und Viola

Applebaum, Edward. Foci: for viola and piano / Edward Applebaum. London: J. & W. Chester/Ed. W. Hansen, 1973.



Bridge, Frank. Two pieces for viola and piano / Frank Bridge. Miami Lakes, Fla.: Masters Music, [1989]

Clarke, Rebecca. Sonata for viola (or cello) and piano / Rebecca Clarke; new introduction by Ann M. Woodward. New York: Da Capo Press, 1986.

Enesco, Georges. Concertstück: for viola and piano / Georges Enesco. Miami Lakes, Fla.: Masters Music, [1988?]

Glinka, Mikhail Ivanovich. Neokonchennaia sonata: dlia al'ta (ili klarneta) i fortepiano / M. Glinka; redaktsiia V. Borisovskogo. Moskva: Gos. Muz. Izd-vo, 1949.

Hummel, Bertold. Albumblatt: viola and piano / Bertold Hummel. Hamburg: N. Simrock, 1989.

Kochan, Günter. Sonate für Viola und Klavier / Günter Kochan. 1. Aufl. Berlin: Verlag Neue Musik, 1988.

Kwiatkowski, Ryszard. Sonata per viola e pianoforte / Ryszard Kwiatkowski. Kraków: Polskie Wydawn. Muzyczne, [1984], 1983.

Milhaud, Darius. I^{ère} sonate pour alto et piano: sur des thèmes inédits et anonymes du XVIII^e siècle / Darius Milhaud. Paris: Heugel, [1975], 1968.

Milhaud, Darius. II^{ème} sonate pour alto et piano / Darius Milhaud. Paris: Heugel, 1946.

Milhaud, Darius. II^{ème} sonate pour alto et piano / Darius Milhaud. Paris: Heugel, [1948?], 1946.

Milhaud, Darius. II^{ème} sonate pour alto et piano / Darius Milhaud. Paris: Heugel, [197?], 1946

Milhaud, Darius. Quatre visages: pour alto et piano / Darius Milhaud. Paris: Heugel, 1946.

Milhaud, Darius. Quatre visages: pour alto et piano / Darius Milhaud. Paris: Heugel, 1946.

Rebikov, Vladimir. Pesnia bez slov / V. Rebikov ; perelozhenie dlia al'ta i fortepiano [D. Lepilova]. Moskva: Gos. Muz. Izd-vo, 1951.

Shirinskiĭ, Vasilii Petrovich. Sonata dlia al'ta s fortepiano = Sonate pour viola et piano / V. Shirinskiĭ. Moskva: Gos. Muz. Izd-vo, 1932.

Vierne, Louis. Deux pièces pour alto avec accompagnement de piano / par Louis Vierne. Paris: A. Leduc, [190?].

Zolotarev, Vasiliiĭ Andreevich. Ekloga: dlia al'ta i fortepiano, soch. 38 = Eclogue: pour viola et piano, op. 38 / V. Zolotarev. Moskva: Gos. Izd-vo, Muzykalnyi Sektor, 1923.

Klavier und Viola (arr.)

Azerbaïdzhanskaia narodnaia pesnia / zapis U. Gadzhibekova; perelozhenie dlia al'ta i forte piano G. Bezrukova. Gruzinskaia narodnaia pesnia / zapis Z. Paliashvili. Liricheskaia pesnia / O. Taktakishvili. Shutochnaia. Moskva: Gos. Muz. Izd-vo, 1954.

Eight pieces for viola and piano / arr. and ed. by Watson Forbes. Miami Lakes, Fla.: Masters Music Publications, [198?].

Elgar, Edward. Two pieces for viola and piano / Edward Elgar. Miami Lakes, Fla.: Masters Music Publications, [1988?]

Fauré, Gabriel. Probuzhenie; Zhaloba / G. Fore. Elegiia / Zh. Massne. Malen'kiĭ pastukh / K. Debussi. Moskva: Gos. Muz. Izd-vo, 1958.

Handel, George Frideric. Kontsert, (h-moll), dlia al'ta i tsifrovannogo basa / G. F. Gendel; obrabotka dlia al'ta i fortepiano A. Kazadeziusa. Moskva: Gos. muz. izd-vo, 1947.

Handel, George Frideric. Sonata no. 6 / G. Gendel; [perelozhenie E. Strakhova]. Moskva: Gos. Muz. Izd-vo, 1954.

Hasse, Johann Adolf. Burre i menuet / I. Gasse. Buree / I.S. Bakh. Sonatina; Menuet / L. Betkhoven. Moskva: Gos. muz. izd-vo, 1954.

Ma, Ssu-ts'ung. Pesnia pastukha / Ma Sy-tsun; obrabotka R. Barshaia. [Moskva: Muzgiz, 1954].

Marais, Marin. Five old French dances: for viola and piano / Marin Marais; arr. by Maud E. Aldis and Louis T. Rowe. Miami Lakes, Fla.: Masters Music, [1989].

Pleyel, Ignaz. Concerto, Viola & Orchester, op. 31 / Ignaz Pleyel; nach der Erstausg. hrsg. von Carl Herrmann. Frankfurt/M: H. L. Grahl, 1951.

Preliudiia, soch. 59, no. 24 / A. Gedike. Andantino / A. Khachaturian. Etiud / D. Kabalevskiĭ; [perelozhenie G. Bezrukova].

Rachmaninoff, Sergei. Sonata for viola and piano, op. 19 / Sergei Rachmaninov; transcribed by V. Borisovsky. Miami Lakes, Fla.: Masters Music, [1988].

Ravel, Maurice. Pavane pour une infante défunte / Maurice Ravel; [transcrite pour alto et piano par G. Drouet]. Paris: Max Eschig, 1921.

Richter, Marga. Aria and toccata: for viola and piano / by Marga Richter. New York: Mills Music, 1961.

Rózsa, Miklós. Konzert für Viola und Orchester, op. 37 = Concerto for viola and orchestra / Miklós Rózsa; Klavierauszug vom Komponisten = Piano reduction by the composer. Wiesbaden: Breitkopf & Härtel, 1988.

Tartini, Giuseppe. Adagio and fugue for viola and piano / Giuseppe Tartini; arr. by Peggy Radmall. Miami Lakes, Fla.: Masters Music, [1898].

Zwei Violinen und Viola

Kodály, Zoltán. Serenade für zwei Violinen und Viola = Szerenád, 2 hegedűre és violára / Zoltán Kodály. Wien; New York: Universal Edition, 1921.

Mozart, Wolfgang Amadeus. Divertimento Nr. 3, 2 Violinen & Viola: Köchel-Verz anhang 229 / Mozart; [barb. für Streichinstrumente von Paul Kelngel]. Leipzig: Breitkopf & Härtel, 1926.

Violine, Viola und Violoncello

Berkeley, Lennox. Trio for violin, viola and cello / Lennox Berkeley. London: J. & W. Chester, [1944].

Constantinescu, Paul. Doua studii în stil bizantin: pentru violină, violă și violoncel / Paul Constantinescu. Cucurești: editura Societății Compozitorilor Români, [1929].

Eybler, Joseph, Edler von. Trio für Violine, Viola und Violoncello, op. 2. / Joseph Eybler; hrsg. von Franz Beyer. Adliswil-Zürich: Amadeus; New York: Edition Eulenburg, 1973.

Hess, Willy. Trio in G-dur für Violine, Viola und Violoncello, op. 76 / Willy Hess. Berg a. I.: Amadeus; New York: Edition Eulenburg, 1974.

Mozart, Wolfgang Amadeus. Streichtriosatz G-dur, KV Anhang 66 / Wolfgang Amadeus Mozart; ergänzt und hrsg. von Franz Beyer. Winterthur: Amadeus; New York: zubeziehen durch Edition Eulenburg, 1976.

Reimann, Aribert. Trio für Violine, Viola und Violoncello / Aribert Reimann. Mainz: B. Schott's Sohne; New York: Schott Music Corp., 1989.

Reimann, Aribert. Trio für Violine, Viola und Violoncello / Aribert Reimann. Mainz; New York: Schott, 1989.

Viola, Violoncello und Contrabass

Hartmann, Erich. Rêverie: "Hommage à Serge Koussevitzky": pour alto, violoncelle et contrebasse: 1984 / Erich Hartmann. Berlin: Bote & Bock, 1985.

Viola, Contrabass und Ziehharmonika

Meijering, Chiel. The Swing of the thing: for accordian, viola and double bass: version 1990 / Chiel Meijering. Amsterdam: Donemus, 1989.

Flöte, Viola und Harfe

Lerdahl, Fred. Six Etudes for flute, viola and harp / by Fred Lerdahl. Hillsdale, N.Y.: Mobart Music Publications; Hackensack, N.J.: Distributor for USA and Canada, Jerona Music Corp., 1981.

Flöte, Oboe und Viola

Holst, Gustav. Terzetto for flute, oboe and viola / Gustav Holst. London: J. & W. Chester, 1944.

Klarinette, Fagott und Viola

Reitz, Heiner. Trio surprise: für Klarinette, Viola und Violoncello oder Fagott = Trio surprise: for clarinet, viola and violoncello or bassoon / Heiner Reitz. Winterthur: Amadeus, 1991.

Klarinette, Trompete und Viola

Raseghi, Andreas. Trio unter dem Weinstock: für Bratsche, Trompete, Klarinette / Andreas Raseghi. Muchen: Ricordi, 1988.



William Robert Scott

Maker of Violas, Violins and Cellos

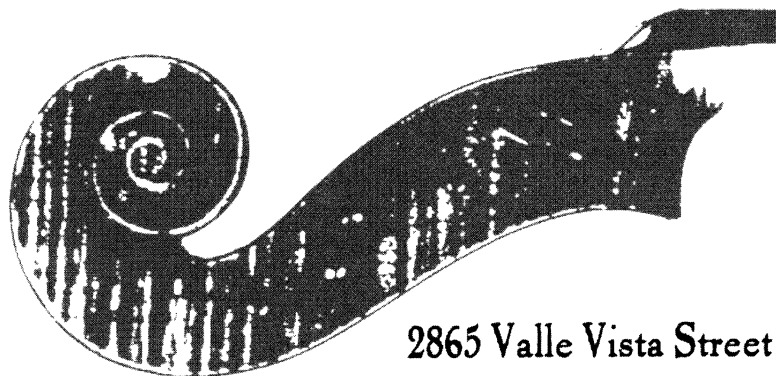

2865 Valle Vista Street
Minneapolis, MN 55427
Tel. 612-544-1021

Awarded consistently over the last 12 years for workmanship and tone.

Holzbauer; hrsg. von Ulrich Drüner.
Zürich: Eulenburg; New York:
Edition Eulenburg, 1976.

Quintette mit zwei Violen

Alain, Jehan. Andante con variazioni
et scherzo pour quintette a cordes /
Jehan Alain. Paris: Leduc, 1990.

Etüden, Capricen, Studien, Übungen

Chailley, Marie-Thérèse. Technique
de l'alto: les exercices au service de
l'expression musicale en 2 volumes =
Viola technique: exercises in the ser-
vice of musical expression in 2 books
/ Marie-Thérèse Chailley. Paris: A.
Leduc, 1990.

Mogill, Leonard. Advanced scales
and double stops for viola / by
Leonard Mogill. New York: G.
Schirmer, 1970.

Viola-Solo mit Orchester

Cambini, Giuseppe Maria. Concerto in D-Dur
für Viola und Orchester = Concerto for viola and
orchestra / Giuseppe Cambini; hrsg. von Karel
Pojar. Winterthur: Amadeus, 1988.

Eröd, Iván. Violakonzert op. 30 / Iván Eröd.
Wien: Doblinger, 1984.

Hummel, Johann Nepomuk. Fantasie, viola &
string orchestra with 2 clarinets / J.N. Hummel;
[arr. for viola and piano by H. Truscott]. London:
Musica Rara, 1973.

Stamitz, Johann. Konzert G-Dur für Viola,
Streichorchester und Cembalo / Johann Stamitz;
zum ersten Mal hrsg. von Rudolf Laugg;
Generalbass-Aussetzung von J. Wojciechowski.
Frankfurt; New York: H. Litolf's Verlag / C. F.
Peters, 1962.

Violine- und Viola-Solo, mit Orchester

Hess, Willy. Doppelkonzert für Violine, Viola
und Orchester, op. 81 / Willy Hess. Winterthur:
Amadeus; New York: Edition Eulenburg, 1976.

Violoncello- und Viola-Solo, mit Orchester

Holzbauer, Ignaz Jakob. Concerto für Viola,
Violoncello und Streichorchester / Ignaz

Primrose, William. Technique is memory: a
method for violin and viola players based on fin-
ger patterns / William Primrose. London: Oxford
University Press, [1960].

Strauss, Richard. Orchester-Studien aus Richard
Strauss' symphonischen und Bühnen-Werken: für
Viola / ausgewählt und bezeichnet von August
Gentz. Leipzig: Universal-Edition; Berlin: Adolph
Furstner, 1912.

Vieux, Maurice Edgard. Dix études pour alto sur
les intervalles / M. Vieux. Paris: Alphonse Leduc,
1931.

*This concludes the 1992 PIVA acquisitions. The
1993 acquisitions will begin next issue.*

*Inquiries about loaning procedures from PIVA
should be addressed to*

*David Day, Music Librarian PIVA
HBLL 5222
Brigham Young University
Provo, UT 84602
Tel (801) 378-6119; fax 378-6708
e-mail: david_day@byu.edu*

*visit the PIVA website at
<http://www.lib.byu.edu/~music/PIVA/WP.html>*

D'Addario Helicore

VIOLA STRINGS

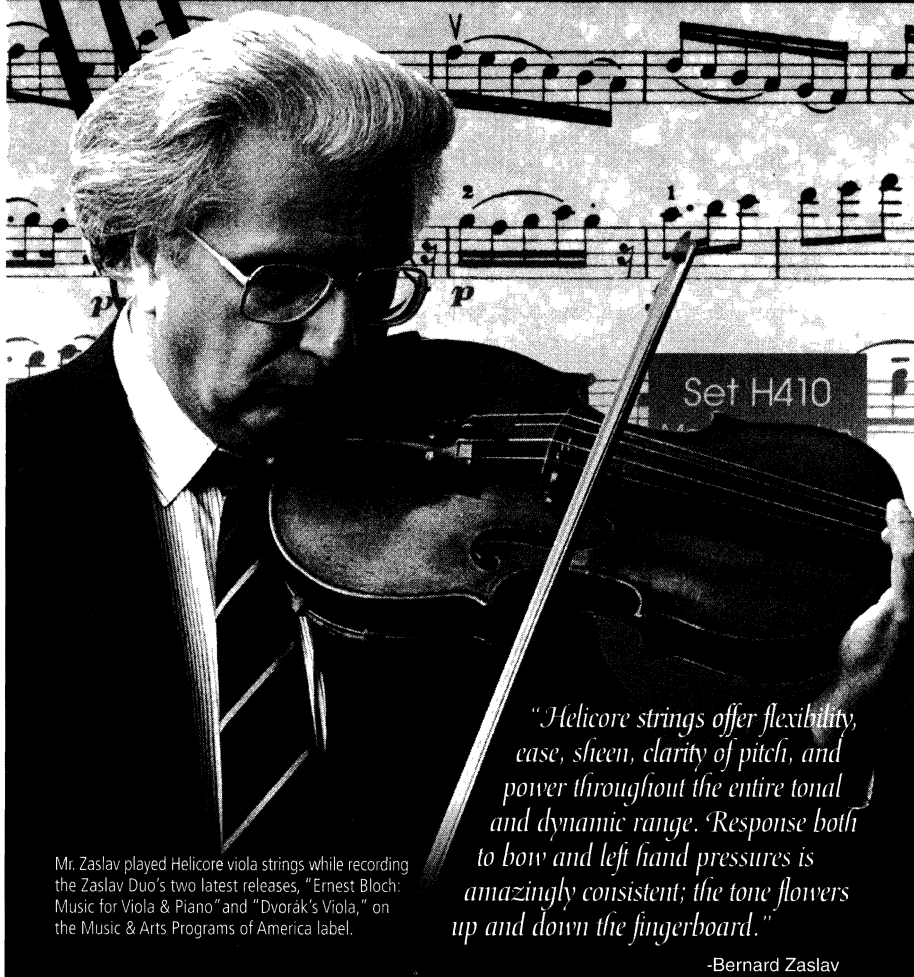

"Helicore strings offer flexibility, ease, sheen, clarity of pitch, and power throughout the entire tonal and dynamic range. Response both to bow and left hand pressures is amazingly consistent; the tone flows up and down the fingerboard."

-Bernard Zaslav

Mr. Zaslav played Helicore viola strings while recording the Zaslav Duo's two latest releases, "Ernest Bloch: Music for Viola & Piano" and "Dvorak's Viola," on the Music & Arts Programs of America label.

J. D'Addario & Company, Inc. • PO Box 290 • Farmingdale, NY 11735 USA
E-Mail: strings@daddario.com • Home Page: <http://www.daddario.com>

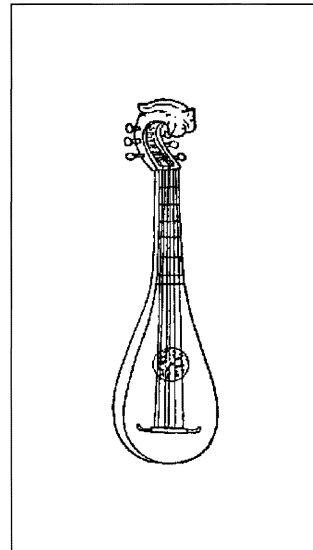

music is art
art is discovery
discovery is thrilling

discover
goldenberg
violins • violas • cellos

Portsmouth, New Hampshire
1-800-286-7592
Handcrafted one-of-a-kinds
starting under \$6,000

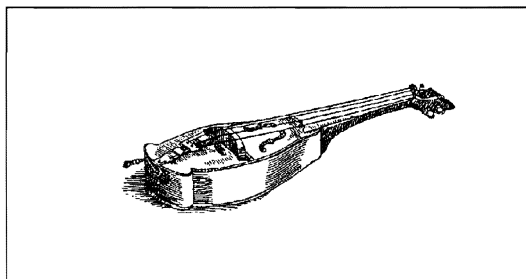

“Curtin & Alf went far beyond anything I expected. My viola is spectacular in every way – the look, the feel, the sound.”

Donald McInnes, Los Angeles 1992

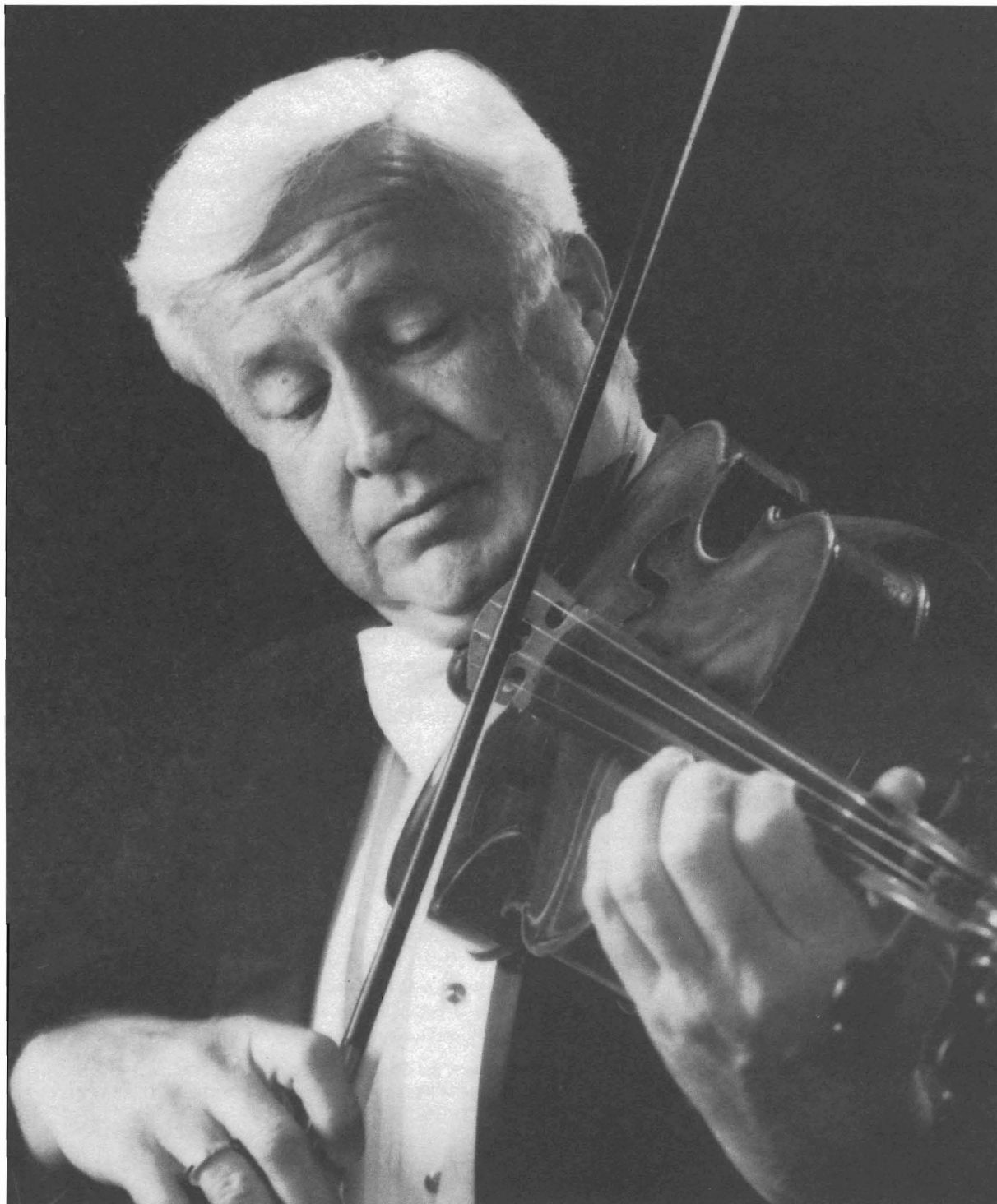

Curtin & Alf

1221 Prospect Street • Ann Arbor, MI 48104 • (313) 665-2014 • Call or write for a free color brochure

OF INTEREST

Musicians Aim for Improvement

From 16 to 19 November 1996, the Cleveland Institute of Music presented a unique program exploring the relationship between the sport of archery and the art of violin playing. Advanced students from CIM were coached each morning by former Olympic archery coach Bud Fowkes and spent the afternoon in master classes led by CIM faculty and guest artist Shlomo Mintz.

The program, known as *Keshet Eilon*, was developed in Israel by violin maker and champion archer Amnon Weinstein, who was in residence at the Institute. Violin playing and archery share a common development of techniques in posture, stance, muscle control, concentration, and focus.

Mr. Mintz, a longtime proponent of this

approach, believes that training in archery can improve string players' skills and help them avoid some of the physical problems they often experience. The program demonstrated that the more accomplished the violinist, the better the archery performance.

Within hours, CIM violin students, most of whom had never picked up a bow and arrow before, were able to shoot with impressive accuracy; by the final day, students were hitting the bull's-eye with astounding consistency.

CIM president David Cerone, who participated in the archery, was intrigued by the similarities between the two activities, clearly pleased to have hosted *Keshet Eilon's* first venture into the United States.



Photo: Herbert Ascherman Jr.

While internationally acclaimed violinist Shlomo Mintz prepares to shoot, students from the Cleveland Institute of Music receive instruction from violin maker and master archer Amnon Weinstein. The group is participating in Keshet Eilon, which took place in November at CIM and explored the relationship between archery and string playing.



William Harris Lee & Company, Inc.
Makers of fine Violins, Violas and Cellos

Making instruments that meet the needs
of a new generation of players.

Call or write for further information:

William Harris Lee & Company, Inc.
410 South Michigan Avenue
Chicago, Illinois 60605
Telephone (312)786-0459 * (800)447-4533
Fax (312)786-9615

Strategies for String Performance Instruction

A pedagogical workshop with a trio of master teachers is planned for 30–31 May and 14 June 1997 at New York University. The faculty are Ronald Leonard, Heidi Castleman, and Dorothy DeLay. Contact: before 1 May, Rick Hatala, tel. (212) 998-5090, or write NYU School of Education, office of Special Programs, 82 Washington Square East, Pless Hall 62, NYC, NY 10003-6644.

Craftsmanship Institute

The 24th Annual Violin Craftsmanship Institute will take place from June through August at the University of New Hampshire at Durham. The faculty consists of Lynn Hannings, Horst Kloss, Karl Roy, and George Rubino. Contact:

Violin Craftsmanship Institute
24 Rosemary Lane
Durham, NH 03824-3528

Erratum

Please note the correct address for *Sixty-Seven Etudes for Solo Cello on the Beethoven Quartets* from page 54 of *JAVS*, vol. 12, no. 3:

Erickson Editions
P.O. Box 666
South San Francisco, CA 94083

ronerick@earthlink.net
<http://home.earthlink.net/~ronerick>



THOMASTIK DOMINANT

THE NEW STANDARD OF EXCELLENCE

WHEN great artists like Pinchas Zukerman, Itzhak Perlman and the Fine Arts Quartet choose their strings, they choose the best. That's why they use 'Dominant' strings for violin, viola, and cello. They have a rich powerful tone, unmatched response and they stay in tune unlike old-fashioned gut strings. They last far longer and are the closest thing to a perfect string ever made.

Now available in Full, 3/4, 1/2, 1/4, 1/8 and 1/16 sizes.
Sold in Better Music Stores

For further information or the name of your nearest
dealer contact the exclusive U.S. Importer

JOHN M. CONNOLLY & CO., INC.
P.O. BOX 93 • NORTHPORT, NEW YORK 11768

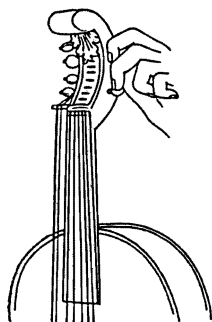

ABOUT VIOLISTS

In Memoriam

With great sadness we mourn the loss of a violist and pedagogue, Abraham Skernick. Mr. Skernick, age seventy-three, died of a heart attack 13 December 1996 in Bloomington, Indiana.

Abraham Skernick will be remembered for the time he spent as principal violist of the Cleveland Orchestra under George Szell from 1949 to 1976. A rich legacy of recorded works is available from this era, but three stand out as particularly memorable for me—the Loeffler *Deux Rhapsodies*, with oboist John Mack and pianist Eunice Podis; the *Sinfonia Concertante* of Mozart, with violinist Raphael Drurian (recently reissued on CD); and the spirited *Don Quixote* of Richard Strauss, with cellist Pierre Fournier (to this day many consider this to be the definitive performance of the work).

Abraham Skernick had a great impact on the lives of many during the course of his long career, especially for those who studied with him. At the urging of his longtime friend and colleague Joseph Gingold, Professor Skernick joined the faculty of Indiana University in 1976 and remained there until his retirement in 1990.

I studied with Mr. Skernick from 1978 to 1983. Many years passed before the sweet smell of his pipe tobacco left my viola. He

was an infinitely patient, articulate teacher, often explaining a concept to me repeatedly until I got it. His quiet demeanor housed incredibly high expectations of his students. Even so, his kind and generous spirit and his occasionally wacky sense of humor tempered the rigors of weekly lessons. He was also the inspiration for, and an ardent supporter of, a series of wild and crazy viola concerts called “Viola Madness.” Whether studying the orchestral excerpts or the standard repertoire, I had complete trust in his advice and judgment.

Those days were rich and my memory of those influential times grows more vivid each day as I work with my own students. At one time or another, most everyone of us has a teacher or mentor who influences us in life-changing ways; Mr. Skernick was certainly such a teacher for me. He was more than just a great musician and teacher—he was and remains the embodiment of all I hope to be—a great violist, a thoughtful and caring teacher, and a kind and generous human being. If I come even marginally close to being like Abraham Skernick, I’ll celebrate the victory and remain forever indebted.

—Debra Moree
Ithaca College

Nathan Gordon

Internationally known
viola virtuoso,
chamber musician, and
pedagogue

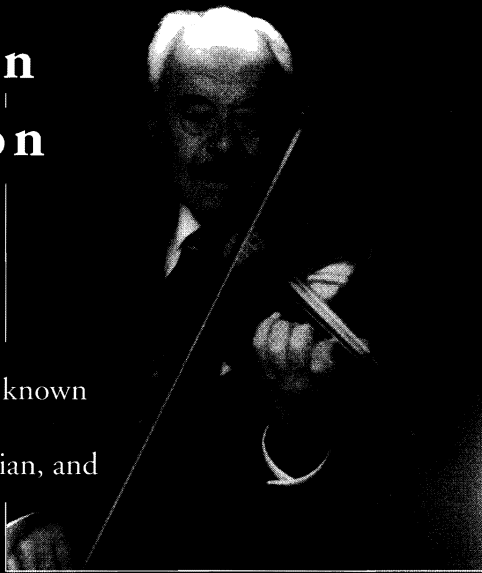

Master classes, string workshops, solo and
orchestral literature

Lee Jon Associates

24 Del Rio Blvd.
Boca Raton, FL 33432
(800) 282-3161 fax (561) 394-0520



Mark Anton Hollinger

VIOLIN MAKER

Award Winning Instruments

VIOLIN • VIOLA • CELLO

Expert Repairs, Acoustical Adjustments
Bows & Accessories

5075 LUPINE ROAD
MISSOULA, MONTANA 59803

406-542-2012

MEMBER A.F.V.B.M.

JAVS Special Offer to AVS Members!

A good gift to students and friends. \$3.00 for any of the following back issues
of the *Journal of the American Viola Society*.

April 1987, Vol. 3 No. 1 _____

Nov. 1987, Vol. 3 No. 3 _____

Spring 1989, Vol. 5 No. 1 _____

Summer 1989, Vol. 5 No. 2 _____

Fall 1989, Vol. 5 No. 3 _____

Summer 1990, Vol. 6 No. 2 _____

Fall 1990, Vol. 6 No. 3 _____

Fall 1991, Vol. 7 No. 2 _____

Winter 1991, Vol. 7 No. 3 _____

Vol. 8 No. 2, 1992 _____

Vol. 9 No. 1, 1993 _____

Vol. 10 No. 1, 1994 _____

Vol. 10 No. 2, 1994 _____

Vol. 10 No. 3, 1994 _____

Vol. 11 No. 1, 1995 _____

Vol. 11 No. 2, 1995 _____

Vol. 11 No. 3, 1995 _____

Vol. 12 No. 1, 1996 _____

Vol. 12 No. 2, 1996 _____

Vol. 12 No. 3, 1996 _____

Die Viola, Vol. 6 _____

Die Viola, Vol. 7 _____

Die Viola, 1985/86 _____

Name _____ Telephone _____

Address _____

City _____ State _____ Zip _____

Make check payable to the American Viola Society and submit to:
David Dalton, Editor JAVS, BYU Music HFAC, Provo, UT 84602

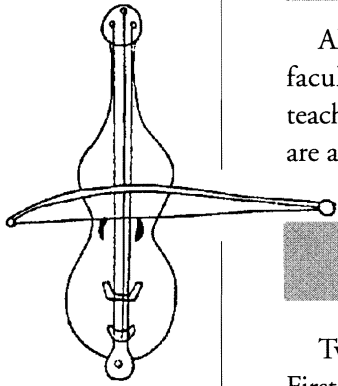

Concerto Premiere

Alanna Wheatley will give the world premiere on 28 April of the Viola Concerto by Juilliard faculty member Michael White. The work is dedicated to Karen Tuttle, Miss Wheatley's teacher, and the performance is under the sponsorship of the Kosciuszko Foundation. Tickets are available at (212) 724-2842.

Viola Affinity

Two interesting references appear in the 1996 September and October issues of *Classic CD*. First, under the title "Pierre Monteux: A Brahms Fanatic," we read:

At a magnificent charity ball given in Paris in 1887, a chubby twelve-year-old Pierre Monteux conducted an orchestra for the first time in a performance of his brother Paul's newly-composed Polka. He delighted the society press and was nicknamed the "chou-chou (little cabbage) of the ladies." Seventy-four years later Monteux signed a contract as principal conductor of the London Symphony Orchestra, insisting on a twenty-five-year contract with an option on another twenty-five. *He was one of the finest violists in Europe and at eighteen played to Brahms:* "All I remember is a sense of strength, a beard, and rather sad eyes," he later recalled. Monteux developed a great passion for Brahms's music and in his last years his house overflowed with memorabilia. "In the mornings, I always see Johannes before I see my wife." [emphasis added]

Second, in reference to the rising American singer Lorraine Hunt (touted as the finest Handelian mezzo since Dame Janet Baker), special note is made of the fact that she began her career as a professional violist.

1997 ASTA Awards

Recipients of the American String Teachers Association's Distinguished Service Award are Almita and Roland Vamos. Almita has been professor of violin and Roland professor of viola and violin at the Oberlin Conservatory since 1992. Between them they teach about sixty students. They have taught at the North Shore Music Center in Chicago since 1972 and formerly served on the faculties of the University of Minnesota and Western Illinois University. Their students have distinguished themselves as winners in numerous national and international competitions.

Appointments in the Northwest

Joël Belgique is the new principal violist of the Oregon Symphony. Helen Callus has been appointed professor of viola at the University of Washington.

The Viola Today in Greater L.A.

After a relatively long break in viola recital activity in southern California, the middle of January 1997 fairly erupted with viola performances. In fact, three major viola programs, as well as a smaller one, took place the same day, Sunday, 19 January, and were followed by several more over the next few weeks.

The first of the programs given on the nineteenth took place at 3:30 p.m. in the Newport Beach Public Library, where the Library Foundation, a volunteer support group, sponsors a series of Sunday afternoon programs. Violist Yvonne Creanga, with pianist Alan Terricciano, presented a program of twentieth-century viola works to an enthusiastic overflow audience. Romanian by birth, Creanga is the wife of Thomas Cockrell, conductor of the University of California–Irvine Symphony. She plays a viola that catches the eye: the upper bouts are shaped like a viola d'amore, which probably makes for greater ease in the higher positions, especially for a smaller person. Built in 1991 by Hiroshi Iizuka, this instrument's tone quality is quite even throughout its range.

A fresh sea breeze from off the sunny beaches close by was conducive to this recital's informal atmosphere (Mr. Terricciano appeared in shirt sleeves). The program contained the Sonata opus 11, no. 4, by Hindemith, "La Californienne" by Milhaud, "Lachrymae" by Britten, and an item new to this writer: Émile Naoumoff's "Petite Suite," consisting of three short, jaunty, pleasantly dissonant movements.

The second of our January 19 performances featured artist Karen Elaine, a great advocate of new works. Her program was broadcast from the Bing Auditorium of the Los Angeles County Museum of Art as part of the "Sundays at Four" radio series (sponsored by Los Angeles County, radio station KUSC, and other agencies). Her first offer-

ing, a work by Todd Barton titled "Translucencies," featured a duet for viola and double bass (played by Bertram Turetzky), with assistance from other strings and the conductor. This work makes use of two non-traditional instruments which the announcer called "waterphones" and vaguely described as having rods in water that are bowed by the performers. Since the broadcast medium was radio, precisely what was happening on stage remained somewhat unclear for listeners as various nonscalar sounds came over the airwaves—squeaks, whistles, harmonics, and glassy noises. A more traditional presentation was Miss Elaine's performance of "Sonata for Viola and Piano" by Myron Fink, with a substantial piano part played by Delores Stevens. Closing the hour-long broadcast was another premier, "Double Exposure, Duo for the Viola and Cello" by Bruce Taub. Couched squarely in the twentieth-century idiom, this work posed considerable technical challenges that seemed aptly met by Miss Elaine and cellist Matthew Cooker.

Also on this viola-packed Sunday, at 5:00 p.m., Jan Karlin, violist of the Southwest Chamber Music Society, was featured in "Variations I" by John Cage; Karlin performed at the Armory Center for the Arts in Pasadena. At 8:00 p.m., at the Pierson Playhouse, Pacific Palisades, Peter Hatch gave his annual viola recital, with Delores Stevens accompanying at the piano. In sharp contrast to the music of Cage, Mr. Hatch presented three viola sonatas from the nineteenth century: one by the prolific French composer George Onslow (1788–1853), one by Henri Vieuxtemps (1820–1881) of violin concerto fame, and one by Paul Juon (1872–1940), whose opus 15 sonata, though twentieth-century by strict chronology, is certainly not twentieth-century in temperament.

The following Thursday evening, 23 January, the London Chamber Orchestra



Béla Bartók's VIOLA CONCERTO

A facsimile edition of the autograph draft is available.

Béla Bartók's last composition was left in the form of sketches, as the composer died before he had the opportunity to prepare a full score. The work became known in Tibor Serly's orchestration; a second variant by Nelson Dellamaggiore and Peter Bartók was recently produced. The facsimile edition shows what has been written by Béla Bartók and what was added or changed by others.

The publication contains full size color reproductions of the sixteen manuscript pages (two are blank) of the sketch; an engraved easy-to-read fair copy, commentary by László Somfai and explanatory notes by Nelson Dellamaggiore, who prepared the fair copy. Texts are in English, Hungarian, German, Spanish and Japanese. Total 92 pages, 15 1/2 x 12 inches (39 x 30 cm), hard cover.

U.S. \$ 100.00

(including postage and handling)

Published by:

Bartók Records

P.O. Box #399, Homosassa, FL 34487

came to the U. C. Irvine campus and featured their music director, Christopher Warren Green, and principal violist, Roger Chase, in Mozart's *Sinfonia Concertante*. Except for lower strings, this ensemble stands while performing, with Green functioning as a conducting concertmaster.

Monday, 3 February, Pamela Goldsmith presented a faculty recital at USC's Hancock Auditorium, again demonstrating that she truly understands the Bach cello suites. Using a modern copy of a baroque bow with her Gasparo da Salò viola, she played the Sixth Suite in D Major. When adapting this work for viola, some of us transpose it to G Major, since it was written for an instrument with a fifth string tuned to e'. Dr. Goldsmith keeps it in D and makes this wonderful music alive and vibrant with some blindingly fast figurations, intelligent use of ornaments, danceable rhythmic quality, and general assumption of baroque style elements that are rarely so convincing and unoffensive to the modern listener. Her playing of the Bach suites should be a model for those who try to give "authentic" performances.

Goldsmith's program also included "Quinte Bicinie for Viola and Tuba" by Rodger Vaughan. *Bicinie* means duets without accompaniment but can also carry the connotation of two-part teaching pieces.¹ The viola-tuba combination makes a fine chamber music couple, and the five brief dance movements are witty and charming. Rodger Vaughan is a USC-trained composer

who has had a long association with Cal State Fullerton. Also good to hear was a performance—at least the third—of a two-movement work for solo viola by Maria Newman, "Dances for Deliverance." So often pieces by a living composer are given a premier and then forgotten.

String quartet performances in southern California continue in ample number; this medium provides exposure for violists whose music we would not otherwise enjoy. Brian Dembow of the Angeles String Quartet seems to be achieving celebrity status, as evidenced by two dramatic photos in the *Los Angeles Times* on 20 February and again on 27 February 1997—both by *Times* photographer Al Schaben. A kind of quartet frenzy occurred in January. No fewer than nine different quartets gave concerts in the Los Angeles area between 12 and 28 January: the Sausalito, Los Amis Musicales, Arlekin (all on 12 January), Miami and American (on 17 January), Kronos, Anders, Juilliard, and St. Petersburg. The words *Los Angeles* evoke a variety of images for different people; yet whatever may come to mind in association with L.A., a healthy enthusiasm for chamber music must be included as part of the area's reputation.

—Thomas G. Hall
Chapman University

¹Standley Sadie, *The New Grove Dictionary of Music and Musicians* 2 (London: Macmillan, 1980), 692.

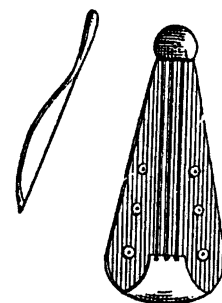

Viola at Manhattan School of Music

Daniel Avshalomov

American String Quartet

Leonard Davis

Soloist with Bernstein, Mehta, Hindemith, Colin Davis, Mitropoulos;
Former Principal, New York Philharmonic

Karen Dreyfus

Lyric Piano Quartet, Orpheus Chamber Orchestra, Partita Chamber Ensemble

Patinka Kopec

Former Member, Andreas Quartet

Cynthia Phelps

Principal, New York Philharmonic

Karen Ritscher

Performances: Orpheus Chamber Orchestra, Opera Orchestra of New York,
American Chamber Players, Killington Music Festival, Library of Congress Chamber Festival

Michael Tree

Guarneri String Quartet

Pinchas Zukerman

(Pinchas Zukerman Performance Program)

Artists-in-Residence
American String Quartet

Mischa Elman Chair, 1996-97
Shlomo Mintz, violin

Offering Bachelor of Music, Master of Music and Doctor of Musical Arts degree programs
in Performance; and Master of Music in Orchestral Performance.



MANHATTAN
SCHOOL OF MUSIC

MARTA ISTOMIN, PRESIDENT

For more information contact: Office of Admission and Financial Aid, 212/749-2802, Ext 2
120 Claremont Avenue, New York, New York 10027

CHAPTERS

McInnes Helps Chicago Chapter Get Underway

Famed violist Donald McInnes recently helped bring to life the new Chicago chapter of the American Viola Society. In town to give a master class at Bein & Fushi, Inc., Mr. McInnes offered a delightful recital at Northwestern University's Lutkin Hall, 2 March, inaugurating the chapter's first organizational meeting.

At the conclusion of McInnes's program—which included sonatas by William Flackton and Thomas Pasatieri (accompanying on piano), the Schubert *Litany*, Ravel's *Habañera*, and *March of the Night Guards* by Eric Korngold—a nucleus of about thirty of Chicago's most active amateur and professional viola teachers and performers remained to discuss the society's formation.

The spirited discussion, led by Iowa State University professor of viola William Preucil

and Suzuki viola teacher and AVS board member Lisa Hirschmugl, produced a long list of ideas and objectives for the nascent organization. These included the sponsoring of solo competitions for players of all ages and levels, providing instructional workshops, creating an archive of local performances, and performing and teaching at public schools.

In addition, the group drew up a slate of names for founding officers. Ballots will be mailed shortly to those who attended the meeting. It is anticipated that Chicago, with its large population of professional and amateur orchestras, music schools, and chamber music ensembles, will be able to support an active and productive viola group devoted to the advancement of viola playing, teaching, and appreciation.

—Les Jacobson



Rocky Mountain Viola Society holds Mini-Congress

The Rocky Mountain Viola Society held its second annual mini-congress, on 14 and 15 February 1997, in Denver, Colorado. Guest artists for this event were Patricia McCarty and David Dalton; clinics were conducted by Mark Braunstein of the William Harris Lee company (on instrument care) and Katherine Mason and Ellen Ravnán (for younger violists, on technique).

McCarty gave an inspirational master class the second day, working with competition winners of the congress. Attendees enjoyed hearing a teacher of McCarty's caliber speak on a wide range of topics, to say nothing of her wonderful performance.

RMVS board members Barbara Hamilton-Primus, Erika Eckert, Margaret Miller, and Juliet White-Smith joined McCarty in a

recital later that afternoon. Basel Vendryes, faculty member at the Lamont School of Music, also performed.

In the afternoon David Dalton lectured with great insight on the life and artistry of William Primrose. For members of my generation of violists who know very little about Primrose, learning more about him from one of his former students was truly inspiring.

The mini-congress provided RMVS members a wonderful opportunity both to hear great artists perform and to become better educated about the instrument we have chosen as our voice—the viola.

—from a report by Lawrence Halverson,
graduate student, University of Northern Colorado

Beautiful Alto Clef Jewelry

Pendants, earrings, tie tacks, cuff links in sterling silver and 14 K gold. All orders custom made by a professional Scottsdale, AZ jeweler.

Classics Unlimited Music

Carolyn Waters Broe (602) 493-3118

4972 E. Paradise Ln.

Scottsdale., AZ 85254

Alto Clef Order Form

___ Ster. Silver Pendant	\$ 25.00
___ Ster. Silver Pendant w/chain	\$ 35.00
___ Ster. Silver Tie Tack	\$ 35.00
___ Ster. Silver Earrings	\$ 75.00
___ 14 K Gold Tie Tack	\$100.00
___ 14 K Gold Pendant	\$ 85.00
___ 14 K Gold Pendant w/chain	\$125.00
___ w/2 Two pt. diamonds add	\$ 50.00
___ 14 K Gold Earrings, clip/post	\$200.00

Include name, address and \$3.50 shipping.

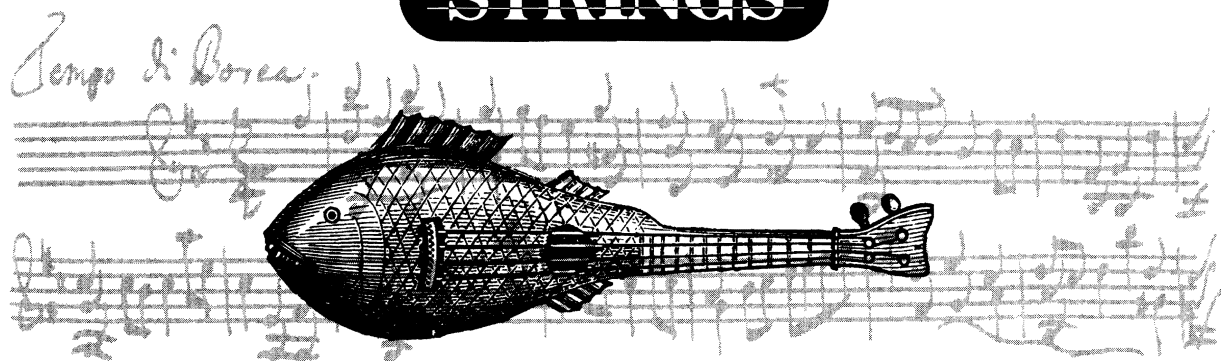

viola da mare

Violins - Violas - Cellos - Bows - Strings - Accessories - Books

Catch us on the net at <http://www.maestronet.com/mcstrings>

email: musiccitystrings@worldnet.att.net

P.O. Box 121761 - Nashville, Tennessee 37212

1-800-336-1980

Utah Viola Festival

Who's that woman sitting in the front with Dr. Dalton?" a friend casually asked as we piled into a bright blue BYU van.

"That's Patricia McCarty," I whispered, "she teaches at the Boston Conservatory!" I was pleased with myself for knowing at least that much, and my friend seemed to be pacified with his new-found knowledge. We had a general idea of what was ahead of us, including a master class by Patricia and a concert including her and our own BYU Chamber Orchestra; but as we passed the time in our blue vehicle, it was evident that we weren't at all prepared for the experiences which were to be ours over the next two days.

During these two days, the 21st and 22nd of February, The Second Annual Utah Viola Festival, organized by UVS President Dr. Michael Palumbo, took place in Salt Lake City. On the schedule were two master classes, two student recitals, a guest lecture, and two professional evening concerts. And by the end of the festival, we had enjoyed a wide variety of music from the viola repertory including, Bach, Bax, Schubert, Stamitz, Bartók, and many others.

While attending the master classes and recitals, I was pleased to observe some of the responses of my peers. I noticed that they not only felt honored to participate, but also that they were inspired to hear people performing on their levels—quite different from a Saturday evening PBS performance, professional as it may be. The opportunity to listen to others play and consequently discover how to improve one's own playing is something which every musician needs.

One of the highlights of the festival was a lecture given by David Dalton. Among other things, he touched on some exciting aspects of the life of the great William Primrose. Because what we learned about Primrose's character was captivating and because Professor Dalton's light-hearted humor lifted our spirits, most of us left feeling completely satisfied that we were violists.

According to common consensus, however, the most moving experience of the weekend was Patricia McCarty's performance of the Walton Concerto. This popular work for the viola has undoubtedly been performed numerous times in different countries, and with various orchestras. Yet, Miss McCarty's performance of the concerto (impressively supported by Dr. Clyn Barrus, who conducted the BYU Chamber Orchestra and who is also a violist), was for me, truly elevating. While casually talking to some of the violists one afternoon before her final concert Patricia said, "You know, I had no idea how valuable slow practice was until I tried it with this concerto! Not only does it calm your mind, but it also puts the piece into your fingers so that they will never fumble again." Her words and music are indeed an inspiration.

The festival's concentrated display of musical talent was more than adequate payment for attendance. I'm convinced that everyone who participated was as satisfied and inspired as I was.

—Marta Franson
viola major, Brigham Young University

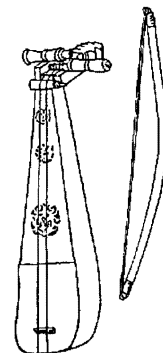

Editor's note: Each local AVS chapter president is requested to send news of chapter activities to the JAVS editor.

BYRON HOYT

SHEET MUSIC SERVICE



(415)431-8055
Fax 1(415)431-0166

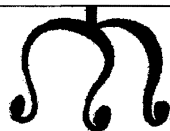

2525 16th Street • San Francisco, CA 94103-4234

The History of the Viola

Volume I (with Supplement)

Revised 1993
(out of print since 1987)

and

Volume II, 1991

Both available NOW

Hard and Soft Cover
\$29.50 and \$24.50 each;
plus Shipping and Handling:
USA \$3.00; Canada \$35.0;
Foreign, USD \$4.00; each

Dr. Maurice W. Riley

Author/Publisher
512 Roosevelt Blvd.
Ypsilanti, MI 48197
Phone: (313) 482-6288

JARGAR • DOMINANT • PIRASTRO • LARSEN • PRIM • HELICORE •

• WINTER • JAEGER • GEWA • REUNION BLUES • SEIKO • MATRIX • WITTNER •

DISCOUNTED PRICES ON
FINE STRINGED INSTRUMENTS,
STRINGS,
CASES &
ACCESSORIES

philip h. weinkrantz
MUSICAL SUPPLY COMPANY

CALL OR WRITE FOR YOUR FREE CATALOG
870 MARKET ST. #1265 . SAN FRANCISCO, CA 94102

800.73.MUSIC OR 800.736.8742

FINKEL • KNOLL • DURRSCHMIDT • SCHICKER • WANKA • ROMA • T.G. PFRETSCHNER • ANDREAS MORELLI • ROMAN TELLER • ERNST HEINRICH ROTH •

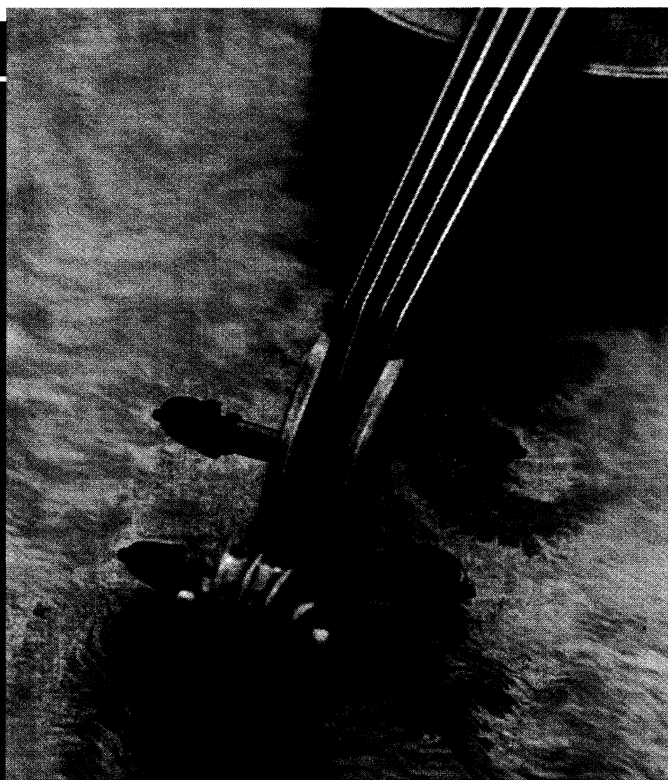

NEW WORKS

Contemporary Etudes and Solos for the Viola, Samuel Rhodes, ed. Commissioned by the American String Teachers Association, copyright 1995. Tichenor Publishing, Division of T.I.S., Inc., P.O. Box 669, Bloomington, Indiana 47402-0669.

Contemporary Etudes and Solos, an anthology of pieces for solo viola, explores and demonstrates the advanced techniques and notation found in virtuoso literature for solo viola from the last part of the twentieth century. This is the last installment in a project by ASTA to publish such a collection for each of the traditional string instruments. The composers represented are Milton Babbitt ("Play It Again Sam"), Maurice Gardner (*Tricinium*, Movement I), Paul Hindemith (Sonata Opus 31/4, Movement III and Sonata, 1937, Movement II), Betsy Jolas (*Épisode Sixième*), Andrew Mead (Sonata, Movements I, II, III), and Arthur Weisberg (Piece for Viola Solo). Jolas is French and Hindemith is German; the others are American composers.

Editor Samuel Rhodes, violist of the Juilliard String Quartet, is the real hero of this collection. He has supplied professional resumes of the composers and helpful explanations about the works. But most informative are his explicit directions for mastering many of the thorniest performance problems. He has added fingerings and bowings to all the entries and, in some cases, suggested practice procedures. Reading and carefully reviewing this anthology is like having an advanced lesson with a great expert in twentieth-century viola technique.

Not everyone will agree with the editor's aesthetic judgment in selecting works for this volume; but new compositional forms are part of our world, and study of this kind of writing will certainly strengthen any violist's technique, even if the music is sometimes regarded as unattractive. The Andrew Mead Sonata seems long, and its quasi-exact procedure for determining note length seems nearly inhuman. A retrogression to tablature-like notation in the Jolas work is interesting but

difficult. In the Weisberg piece, which is notated largely in thirty-second notes, the use of three staves to show three different metronome settings simultaneously is upsetting, and probably imperceptible to the listener. The Hindemith sonatas are valuable, as they are shown with Hindemith's own fingerings.

The introduction to the anthology (which no doubt has been in preparation for some years) contends that the Hindemith sonata movements are hitherto unpublished items, when in fact they were published in 1992 and made available in the United States in 1994,¹ albeit without Hindemith's markings or Mr. Rhodes's valuable performance notes.

The design of *Contemporary Etudes and Solos* has some outstanding features. Its good heavy paper and spiral binding work well on a music stand. The actual music orthography runs from clearly professional in quality (Babbitt) to expedient, hard-to-read manuscript (Weisberg). In this age of computer generated music writing, we probably should expect better. Also, this volume is clearly for study only, as no consideration is given to the page-turn problem. Of course, this aspect of new music is not unique to this publication; perhaps audiences need to become accustomed to the solo violist appearing on stage with an assistant, or with a row of music stands, allowing for a kind of migration across the concert platform.

All in all, three cheers for Samuel Rhodes and ASTA for this giant effort in providing violists with this solid how-to manual in a difficult and esoteric field!

—Thomas G. Hall
Chapman University

¹Please see *Journal of the American Viola Society*, Vol. 11, No. 1, pp. 42–43.

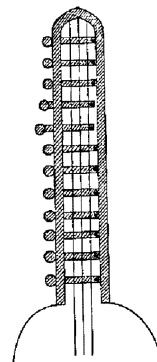



Miller & Fein

STRINGED INSTRUMENTS

*Makers, Restorers and Dealers of
Violins, Violas, Cellos and Bows*

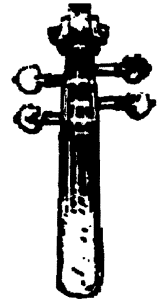

We offer a fine selection of instruments and bows in a wide range of prices, including master-crafted instruments from several European countries and eras, and restored instruments from some of the finer ateliers of France and Germany.

Advancing Students need high quality instruments with excellent projection and a warm, clear tone. Miller & Fein presents an outstanding selection in the \$1,000 to \$4,000 price range.

We feature handmade instruments and bows by some of the finest makers from around the world, including Tambovsky and Krutz, Amnon Weinstein, Whitney Osterud, Joseph Krosnowski, K. Gerhard Penzel, Nicolas Delaune, F. Vincent a Lyon, Andrew Fein and many others. Handcrafted bows priced from \$1,200. Master-made instruments priced from \$5,000.

Our Hours: Monday, Wednesday and Friday 10–6
Tuesday and Thursday 10–8
Saturday 10–4
Closed Sunday

Please make appointments to try instruments or bows.

Every virtuoso was a beginner once. . . . that's why they're important to us.
Ask about our great rental instrument plan.

In St. Paul's Historic Cathedral Hill District
The Blair Arcade, at Selby & Western Avenues
165 Western Avenue North, Saint Paul, MN 55102

612/228-0783 800/347-9172

RECORDINGS

Chamber Music Discography of William Primrose

- J.S.Bach: Sinfonias, no. 3 in D major,
no. 4 in D minor, no. 9 in F minor
RCA Victor: LP - AGL 1-4947, LSC 2563,
LM 2563
CD - GD 87964-2-RG, HC Vol.37
Cass. 87964-4 -RG
Recorded 8/17/1960
Other performers: Jascha Heifetz, Gregor
Piatigorsky
- Beethoven: Duet (Eyeglass Duet)
RCA Victor: 78 RPM - G DB 6225
(Vic. 11 8620)
LP - Vic 1476
CD - Biddulph LAB 088
Recorded 8/29/1941
Other performer: Emanuel Feuermann
- Beethoven: Quartet for Piano and Strings in
E^b major op. 16
RCA Victor: LP - LSC 6068, LM 2200,
LSC 2200
Recorded 1957
Other performers: Szymon Goldberg,
Nicholas Graudan, Victor Babin
- Beethoven: Quintet for Strings in C major
LP (Issued in Australia)
Recorded 1979?
Other performers: Sydney String Quartet
- Beethoven: Quintet for Strings in C major
Columbia: 78 RPM— C.LX 546/9 Set 285,
G OX 10822/5, 68943/6D
Set M 294
Recorded —
Other performers: Lener Quartet
- Beethoven: Trio for Strings in op. 8 (Serenade)
RCA Victor: LP - LM 2550, LSC 2550,
SER 5729/31, HC VOL 25
Cass. 7870-4-RG (m/s)
CD - GD 7870 RG (m/s)
Recorded 8/15,22/1960
Other performers: Jascha Heifetz, Gregor
Piatigorsky
- Beethoven: Trio for Strings op. 9 no. 1
RCA Victor: LP - LM 2186, 6-CRM6-2264 (m)
Ser 5729/31
CD - HC Vol. 10
Recorded 3/27/1957
Other performers: Jascha Heifetz, Gregor
Piatigorsky
- Beethoven: Trio for Strings op. 9 no. 2
RCA Victor: LP - AGL1-4947, LSC 2563,
LM 2563, SER 5729/31
CD - HC Vol. 42
Cass. - 7873-4-RG
CD - 7873-2-RG
Recorded 8/17,22/1960
Other performers: Jascha Heifetz, Gregor
Piatigorsky
- Beethoven: Trio for Strings op. 9 no. 3
RCA Victor: LP- LM 2186, SER 5729/31, 6
CRML-2264 (m)
CD - HC Vol. 10
Recorded 3/27/1957
Other performers: Jascha Heifetz, Gregor
Piatigorsky
- Benjamin: Romantic Fantasy
RCA Victor: LP - LSC 2767, LM 2767,
SB 6605,
CD - HC Vol. 31
Recorded 10/1/1956
Other performers: Jascha Heifetz, Izler
Solomon, cond.
- Brahms: Sextet for Strings op. 36
RCA Victor: LP - LD 6159, LDS 6159,
LSC 2739, LM 273
Cass. 7965 -4-RG
CD - 7965-2-RG, HC Vol. 41
Recorded 8/28,29/1961
Other performers: Jascha Heifetz, Israel Baker,
Virginia Majewski, Gregor Piatigorsky, Gabor
Rejto
- Brahms: Quartet for Strings op. 67
RCA Victor: 78 RPM - Unissued
Biddulph - CD- LAB 053
Recorded 1/15 and 8/5/1941
Other performers: Oscar Shumsky, Josef
Gingold, Harvey Shapiro
- Brahms: Quartet for Piano and Strings op. 25 no. 1
RCA Victor: LP - LSC 2473, LM 2473,
LSC 6068
Recorded 1957
Other performers: Szymon Goldberg, Nicolai
Graudan, Victor Babin
- Brahms: Quartet for Piano and Strings op. 26 no. 2
RCA Victor: LP - LSC 2517, LM 2517,
LSC 6068

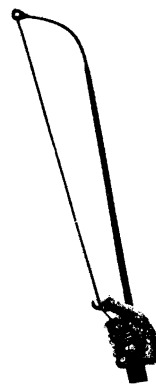

Viola Faculty

At the San Francisco Conservatory,
we have a faculty for great music.

Don Ehrlich, assistant principal viola of the San Francisco Symphony, has been a frequent soloist and chamber musician in the Bay Area and around the world. He received his B.M. from the Oberlin Conservatory, his M.M. from the Manhattan School of Music and his D.M.A. from the University of Michigan.

Leonid Gesin is a member of the San Francisco Symphony and several chamber music groups, including the San Francisco Chamber Orchestra. He studied with A.G. Sosin at the Leningrad State Conservatory, then performed with the Leningrad State Philharmonic and taught before emigrating to the United States.

Paul Hersh, former violist and pianist of the Lenox Quartet, studied viola with William Primrose and attended Yale University. He has performed with the San Francisco Symphony, the San Francisco Chamber Orchestra and many other groups. He has also made a number of recordings and has been artist-in-residence at universities and music festivals in the United States and Europe.



Geraldine Walther, principal violist of the San Francisco Symphony, is former assistant principal of the Pittsburgh Symphony and a participant in the Santa Fe Chamber Music Festival. She studied at the Curtis Institute of Music with Michael Tree and at the Manhattan School of Music with Lillian Fuchs, and won first prize in the William Primrose Viola Competition in 1979.



Students from around the world come to the San Francisco Conservatory of Music for several reasons:

- A student-teacher ratio of 6 to 1.
- The opportunity to study with an exceptional faculty in one of the world's most diverse and exciting cultural centers.
- Extensive performance opportunities both on campus and around the city. Concerts and recitals are presented at the Conservatory's Hellman Hall nearly every day of the school year.

Offering the Master of Music, Bachelor of Music and Music Diploma. Founded 1917.
Colin Murdoch, President. Deborah Berman, Dean.
Affirmative Action/Equal Opportunity Employer

For more information, contact the Office of Student Services,
San Francisco Conservatory of Music
1201 Ortega Street, San Francisco, CA 94122-4498
Tel 415/759-3431 Fax 415/759-3499
<http://www.sfc.edu>
e-mail: jgordon@sirius.com

San Francisco Conservatory of Music

Recorded 1957

Other performers: Szymon Goldberg, Nicolai Graudan, Victor Babin

Brahms: Quartet for Piano and Strings op. 60 no. 3

RCA Victor: LP - LSC 2330, LM 2330,
LSC 6068

Recorded 1957

Other performers: Szymon Goldberg, Nicolai Graudan, Victor Babin

Brahms: Quartet for Piano and Strings op. 60 no. 3

Off the air - noncommercial recording

Recorded 196-?

Other performers: Michael Gulli, Janos Starker, Menachem Pressler

Dohnanyi: Serenade in C

RCA Victor: 78 RPM - G.DB 61433/5,

Vic 11-8176, Set M 903

LP LVT 1017, AGM 1-4942 (m)

Biddulph-CD LAB 074, RCA Victor-HC Vol. 32

Recorded 9/8/1941

Other performers: Jascha Heifetz, Emanuel Feuermann

Faure: Quintet for Piano and Strings

RCA Victor: LP - LSC 2735, LM 2735

Recorded 1957

Other performers: Szymon Goldberg, Nicolai Graudan, Victor Babin

Franck: Quintet for Piano and Strings

RCA Victor: LP - LSC 2739, LM 2739,

SB 6652, LDS 6159, LD 6159

CD - HC Vol. 33

Recorded 8/21,22/1961

Other performers: Jascha Heifetz, Israel Baker, Gregor Piatigorsky, Leonard Pennario

Handel-Halvorsen: *Passacaglia*

RCA Victor: 78 RPM - Victor 11-8151,

HMV G. DB 6170 ED 357

LP - LVT 1014, RCA 6 CRM6-2264 (m),

Biddulph CD LAB 074, RCA 6264S, HC Vol. 9

Recorded 5/22/1941

Other performer: Jascha Heifetz

Haydn: *The Seven Last Words of Christ* (String Quartet)

RCA Victor: 78 RPM - 17786/94 Set M 757

Biddulph-CD - LAB 052/53

Recorded 2/6,15/1940

Other performers: Oscar Shumsky, Josef Gingold, Harvey Shapiro

ARTIST QUALITY * HANDMADE VIOLINS * VIOLAS * CELLOS



Constructed in the classical Italian tradition for demanding amateur & professional musicians



TERENZIO RIEGEL

1019 West Main Street
Box 364
Valley View, PA 17983
717-682-3853

Free literature available upon request

Kreisler: Quartet for Piano and Strings

RCA Victor: 78 RPM Victor 14249/52 in set

M335, G.DB 2483/6

LP IGI 332, TL Clear TLC 2582

Biddulph 3 LAB 001-3 (m)

Recorded 1935

Other performers: Fritz Kreisler, Thomas Petrie, Lauri Kennedy

Kreisler: Scherzo for String Quartet

RCA Victor: 78 RPM - G.DB 2486

EMI - LP - IGI 332

Biddulph - 3 LAB 001-3 (m)

Recorded 1935

Other performers: Fritz Kreisler, Thomas Petrie, Lauri Kennedy

Mendelssohn: Octet for Strings

RCA Victor: LP - LSC 2738, LM 2738, Set

LD/LDS 6159, A 640761/3

CD - HC Vol. 35

Recorded 8/24,25/1961

Other performers: Jascha Heifetz, Israel Baker, Arnold Belnick, Joseph Stepansky, Virginia Majewski, Gregor Piatigorsky, Gabor Rejto

NEW RELEASES

Ten Easy Hymns

All melody in 1st position • arr. Hunter/Latham

Hymns: Volume II

Adv. intermediate to 3rd position • arr. Taranto

Brandenburg Concerto #2

for String Quartet arr. Latham • All parts active

Free Catalog

Fast Service

Viola Power T-Shirt - \$13.50

Viola Power Tote Bag - \$8.95

Latham Music Enterprises

1209 Gregory Street Greensboro, NC 27403
(800)645-7022 (US) or (910)273-1499 (FAX)

Mozart: Divertimento K 563
RCA Victor: 78 RPM VIC 11 8846/9 Set 959,
RL 4247(6)
45 RPM - WCT 27
LP LCT 1150, LCT 1021, LVT 1014, RCA 6
CRM6-2264 (m)
RL 42474(6)
CD - HC Vol. 9
Biddulph - CD - LAB 074
Recorded 9/9/1941
Other performers: Jascha Heifetz, Emanuel
Feuermann

Mozart: Duo no. 2 for Violin and Viola K 424
RCA Victor
78 RPM 18195/7S, Set M 831
LP LVT 1014, RCA 6 CRM 6-2264 (m),
LCT 1150, RL 42474(6)
Biddulph-CD - LAB 074
RCA Victor
CD - HC Vol. 9
Recorded 5/22/1941 and 8/29/1941
Other performer: Jascha Heifetz

Mozart: Quartet for Piano and Strings
Non-commercial recording, Live recording
from University of Indiana
Recorded 12/6/1968
Other performers: Josef Gingold, Janos
Starker, Gyorgy Sebok

Mozart: Quartet for Piano and Strings no. 12,
K 387
The Strad Magazine - CD - Strad 7
Recorded 1940
Other performers: Oscar Shumsky, Josef
Gingold, Harvey Shapiro

Mozart: Quintet for Strings, K 406
Vanguard Classics
LP- 2060/2, 081 8024/5
CD- OVC 8025, 08802471, KICC 81/2
(Japan)
Recorded 9/11-19/1959
Other performers: Griller Quartet

Mozart: Quintet for Strings, K 515
Bach Guild - LP HM 29 SD,081 8024/5,
2060/2.
SRV 158 SD
Vanguard Classics - CD OVC 8025,
08802471,
KICC 81/2 (Japan)
Recorded 9/11-19/1959
Other performers: Griller Quartet

Mozart: Quintet for Strings, K 515
RCA Victor: LP - LSC 3048, LM 3048,
ALG 14949
CD - HC Vol. 34
Recorded 3/26,27/1964
Other performers: Jascha Heifetz, Israel Baker,
Virginia Majewski, Gregor Piatigorsky

Mozart: Quintet for Strings, K 516
RCA Victor: LP - LSC 2738, LM 2738, Set SD
6159, A 640761/3
Cass. 7869-4-RG (m/s)
CD 7869-2-RG (m/s), GD 87869, HC Vol. 26
Recorded 8/29,30/1961
Other performers: Jascha Heifetz, Israel Baker,
Virginia Majewski, Gregor Piatigorsky

Mozart: Quintet for Strings, K 516
Bach Guild - LP -HM 29 SD, 081
8024/5,2060/2, SRV 158 SD Vanguard
Vanguard Classics - CD - OVC 8024,
08802471, KICC 81/2 (Japan)
Recorded 9/11-19/1959
Other performers: Griller Quartet

Mozart: Quintet for Strings, K 593
Vanguard - LP - SRV 194 SD, 081 8024/5,
2060/2
Vanguard Classics - CD OVC 8024,
081802471, KICC 81/2 (Japan)
Recorded 9/11-19/1959
Other performers: Griller Quartet

Mozart: Quintet for Strings, K 614
Vanguard - LP - SRV 194 SD, 081 8024/5,
2060/2
Vanguard Classics - CD - OVC 8025,
08802471, KICC 81/2 (Japan)
Recorded 9/11-19/1959
Other performers: Griller Quartet

Schubert: Quintet for Strings op. 163, D.956
RCA Victor: LP - LSC 2737, LM 2737, Set LD
6159, LDS 6159
RCA Victor (Gold Seal) Cass. 7964-4 RG
CD - 7964-2-RG, GD 87974, HC Vol. 37
Recorded 11/30 and 12/1/1961
Other performers: Jascha Heifetz, Gregor
Piatigorsky, Israel Baker, Gabor Rejto

Schubert: Quintet for Strings and Piano, (Trout)
D 667
RCA Victor: LP - LSC 2735, LM 2735, VICS
1399, CCV 5046
Recorded 1957
Other performers: Szymon Goldberg,
Nicholas Graudan, Victor Babin, Stuart Sankey

Schubert: Trio for Strings D 471
RCA Victor: LP-LSC 2563, AGLI -4947,
LM 2563
Cass. 7964-4 RG
CD - 7964-2 RG, GD 87964, HC Vol. 37
Recorded 8/16,22/1960
Other performers: Jascha Heifetz, Gregor
Piatigorsky

Schumann: Quartet for Piano and Strings op. 47
RCA Victor: LP - LSC 6068, LM 2200, LSC
2200
Recorded 1957
Other performers: Szymon Goldberg,
Nicholas Graudan, Victor Babin

Schumann: Quintet for Piano and Strings op. 44
RCA Victor: 78 RPM - 176023, Set M736
Biddulph -CD- LAB 053
Recorded 3/14/1940
Other performers: Oscar Shumsky, Josef
Gingold, Harvey Shapiro, Jesus-Maria
SanRoma

VIOLA AT BUTLER



Donna Lively Clark
Professor of Viola

Butler offers professional
music and music education
degrees supported by a major
scholarship program and
strong liberal arts education

Butler String Faculty:
Stanley DeRusha,
Director of Orchestral
Activities
Davis Brooks, violin
Lisa Brooks, violin
Donna Lively Clark, viola
Robert Goodlett II, string bass
William Grubb, cello
Laurence Shapiro, violin



**BUTLER
UNIVERSITY**

Jordan College of Fine Arts
Indianapolis, Indiana
For more information, call
800/368-6852, ext. 9637

Smetana: Quartet for Strings (From My Life)
RCA Victor: 78 RPM - 16313/16, Set M 679
Biddulph - CD - LAB 053
Recorded 2/6, 16/1940
Other performers: Oscar Shumsky, Josef
Gingold, Harvey Shapiro

Tchaikovsky: Quartet for Strings op. 30
(Previously unissued)
Biddulph - CD - LAB 053
Recorded 2/15/1940
Other performers: Oscar Shumsky, Josef
Gingold, Harvey Shapiro

Mozart: Quartet for Oboe and Strings
Columbia: LP - ML 4566, Set 167
Recorded 7/1951
Other performers: Marcel Tabuteau,
Isaac Stern, Paul Tortelier

I would like to thank David Hermann for his 'fine-tuning' of this compilation. Any corrections or additions will be most gratefully received.

—David O. Brown, Brentwood, New York



Other Recordings

Sir Malcolm Arnold: Concerto for Viola and Chamber Orchestra. Other works on this two-disc set. **Roger Best**, viola, et al. BBC Radio Classics 15656 91817-2.

Brahms: Sonatas for Viola and Piano, op. 120, no. 1, no. 2; **Laurent Verney**, viola; Nicholas Angelich, piano. Harmonia Mundi, France 911565.

Bax: Fantasy Sonata for Viola, What the Minstrel Told Us, In a Vodka Shop, 2 Russian Pictures, Tone Pictures, Lullaby, Legend for Viola. **Paul Crabtree**, viola; Matthews, piano. Olympic OLY 454.

Berlioz: Harold in Italy, Overtures—Roman Carnival and Le Corsaire. **Laurent Verney**, viola; Orchestra of the Opera Bastille, Paris; Myung Whun Chung, cond. Harmonia Mundi, France.

Berlioz: Harold in Italy, Tristia. **Gerard Caussé**, viola; Monteverdi Choir; Orchestre Révolutionnaire et Romantique; John Eliot Gardiner. Philips 446-676.

Review: Bypass this ill-conceived version of the ever popular Harold. This shows Caussé in the unkindest light, with little or no vibrato and little emotion in this superromantic composition. Possibly Mr. Gardiner should restrict his original-instrument fixation to the Baroque, with which he has much more experience.

Berlioz: Harold in Italy, Reverie et Caprice, Les Francs Juges. **Rivka Golani**, viola; Igor Gruppman, violin; Joav Talmi, cond. San Diego Symphony Orchestra, Naxos 553034.

Britten: Viola Elegy, Metamorphoses after Ovid, Cello Sonata, Violin Suite. **Paul Silverthorne**, viola, et al. EMI 55398.

Hindemith: Sonatas for Viola, Meditation, Trauermusik. **Paul Carter**, viola; Jordi Vilaprinp, piano; Philharmonia Orchestra; Martyn Brabbins, cond. ASV(F).

Alun Hoddinott: Viola Concertino, Dives and Lazarus, Nocturnes and Cadenzas, Sinfonia Fedei. **Czaba Erdelyi**, viola, et al.; Welsh Opera and Philharmonia Chorus; New Philharmonia; Philharmonia Orchs.; David Atherton and Sir Charles Groves, conds. Lyrita SRCD 332 (ID).

Hindemith: Kammermusik nos. 1, 4, & 5. **Wolfram Christ**, viola; Kolja Blacher, violin; Berlin Philharmonic; Claudio Abado, cond. EMI-Angel #56160.

William Mathias: Divertimento for Violin and Viola. Other compositions for violin, cello, and piano. **Edward Adelson**, viola, et al. Koch International 3-7326-2.

Mozart: Sinfonia Concertante, K 364. **Sigiswald Kuijken**, viola; Ryo Terakado, violin. Le Petite Band, Denon CD 78837.

George Onslow: Sonatas for Viola and Piano. **Pierre Franck**, viola; Francois Joel Thioller, piano. Pierre Verany PVY 796032.

Starer: Viola Concerto. Other compositions by Lees, Kupferman, Colgrass, Harrison, Piston and Bergsma. **Melvin Berger**, viola, et al. VOX 5138 (2CDS).

Schnittke: Trio for Strings, Concerto for Three. Berg: Canon (Arr. by Schnittke). **Yuri Bashmet**, viola; Gidon Kremer, violin; Mstslav Rostropovich, cello. Angel 55627.

Schumann: Fantasiestücke, Märchenbilder, Adagio and Allegro, Romanzen, Märchen-erzählungen. **Henrik Frenzen**, viola; Staffan Martensson, clarinet; Erik Lanninger, piano. Chamber Sound CSCD 95013.

Hommage a Primrose—compositions by Vitali, Joachim, Brahms, Paganini, Wieniawski, and Rachmaninoff. **Harmut Lindemann**, viola; Ben Martin, piano. Tacet 45 (Jem Records, NY).

Review: This disk of the formidable violist Hartmut Lindemann joins two others on the Tacet label—Tacet 21 from 1991 and Tacet 35 from 1993. Lindemann emigrated to Australia from Germany in 1982 at the age of 29. On this disk is one Primrose arrangement—that of the Caprice no. 24 by Paganini, which Primrose recorded on several occasions, including the famous video from the mid-1940s. Primrose was consistent on all the versions, but Lindemann chooses to make some changes. Notes accompanying this disk offer no explanation as to why he does so. He also makes a change in the Joachim Variations, substituting one of his own for Variation no. 9.

Lindemann has an excellent technique and a warm, smooth vibrato which he claims is a key ingredient for all great violists. Ben Martin is a very capable accompanist who takes no backseat to the talents of Lindemann, whose viola was made by an Australian in 1940 and has a lovely tone sounding far older than its years. All three CDs make valuable additions to the viola discography.

Walton: Concerto for Viola (recorded 5/5/1986). Other compositions by Britten (nonviola). **Yuri Bashmet**, viola; Gennady Rozhdestvensky, cond.; USSR State Symphony Orchestra. Revelation (m) RV 10010.

Bernd Zimmerman: Sonata for Viola. Other works for cello and violin. **Christoph Schiller**, viola; Thomas Zehetmair, violin; Thomas Demenza, cello. ECK 1571449904-2.

*—the foregoing submitted by David O. Brown,
Brentwood, New York*

The London Viola Sound. The 48 violas of the Academy of St. Martin in the Fields; BBC Symphony Orchestra; The London Philharmonic; Orchestra of the English National Opera; Geoffrey Simon, cond., in works by Gershwin, Weill, Shostakovich, Dvořák, Grainger, Ravel Prokofiev, Bacharach, & Strayhorn. Cala CACD 0106.

New York Legends (recitals with principals from the New York Philharmonic). **Cynthia Phelps**, viola, with Judith Gordon, piano, Jeanne Baxtresser, flute, in works by Britten, Devienne, Enescu, Hindemith, Paulus, & Schumann. Cala CACD 0510.

Passion. **Rozanna Weinberger**, viola, and Evelyne Luest, piano, in works by Rochberg, Enescu, Noland, Steinke, & Gabel. NPM LD 003.

Primrose Plays Suzuki. William Primrose, viola, and Yuko Hirose, piano, in Suzuki Method (Vols. 1-2, and Allegro by Fiocco. FPCD2248.



COMPETITIONS

Lionel Tertis International Viola Competition & Workshop

Lionel Tertis International Viola Competition and Workshop, 23–30 August 1997, Isle of Man, U.K. Contact: Lionel Tertis Sekretariat, Erin Arts Centre, Victoria Square, Port Erin, Isle of Man IM9 6LD, British Isles; tel. +44 (0) 1624 832662; web page: <http://www/enterprise/net/arts/tertis.htm>

Irving M. Klein String Competition

Irving M. Klein String Competition, 24–15 June 1997, ages 15–23. Prizes from \$250 to \$8,000. Contact: IMK Competition, San Francisco State Music Dept., 1600 Holloway Ave., San Francisco, CA 94132.

46th International Music Competition of the ARD

46th International Music Competition of the ARD, Munich, 2–19 September 1997. Prizes in viola section from \$6,000 to \$13,000. Contact: Internationaler Musikwettbewerb, Bayerischer Rundfunk, D-80300 Munich, Germany. Tel. (089) 5900-2471; fax (089) 5900-3573.

Viola Connotations

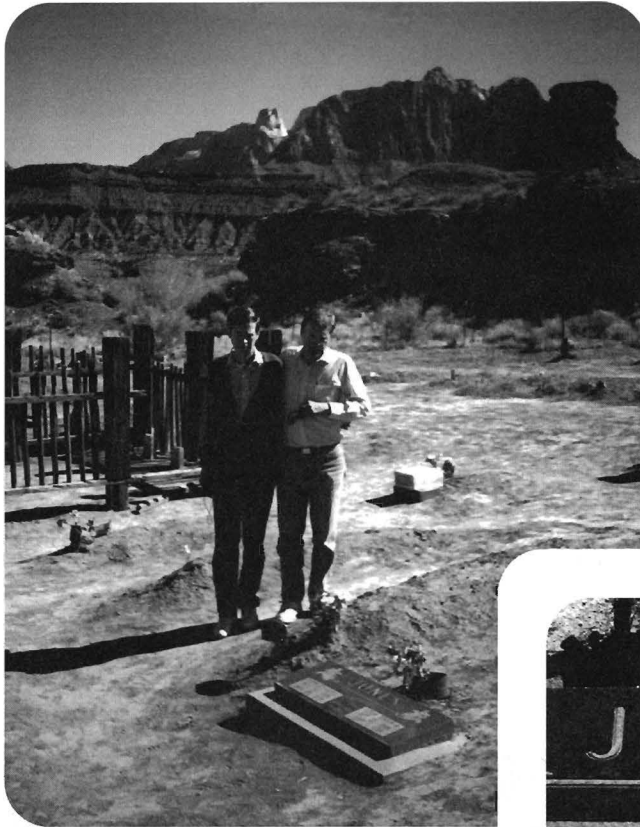

In quiet
contemplation
of a
deceased Viola . . .



Yizhak Schotten and David Dalton
pause to pay homage in the pioneer
cemetery at Crafton . . .

Utah's most famous ghost town and site of the
filming of *Butch Cassidy and the Sundance Kid*
with Paul Newman and Robert Redford.



*Please submit your informative photos of license plates, commercial products, & unusual
associations that keep our name before the public.*



Graphics for this issue from *The Stringed Instruments of the Middle Ages: Their Evolution and Development*, from the Danish of Hortense Panum, edited by Jeffrey Pulver (William Reeves, Bookseller Ltd., London); also, courtesy of *Le Violon: Histoire, esthétique, facture et acoustique* by Emile Leipp (Hermann, 115, boulevard Saint Germain, Paris 6).



THE AMERICAN VIOLA SOCIETY (AVS) is an association for the promotion of viola performance and research. Your personal and financial support is appreciated. As an AVS member, you receive three issues of the Society's journal (*JAVS*) each year and *The Viola* as it is published by the International Viola Society. Membership also brings you the satisfaction of knowing you belong to a collegial group dedicated to the furtherance of our instrument and its literature.

Please enroll me /my group/ in the American Viola Society (AVS) for one year and begin my subscriptions to JAVS and The Viola. My check for one year's dues, payable to the American Viola Society, is enclosed, in the amount indicated here:

- | | |
|--|---|
| <input type="checkbox"/> \$30 Renewal Membership | <input type="checkbox"/> \$100 or more AVS Benefactor |
| <input type="checkbox"/> \$30 New Membership | <input type="checkbox"/> \$50 to \$100 AVS Contributor |
| <input type="checkbox"/> \$15 Student Membership | <input type="checkbox"/> \$35 International Membership
(Residing outside the U.S.) |
| <input type="checkbox"/> \$40 Joint Canadian/AVS Membership
(includes both CVS newsletter and <i>JAVS</i>) | |

- I wish to contribute to the Primrose Memorial Scholarship Fund in the amount of \$_____ .
- I wish to make a tax-deductible contribution to the AVS Endowment in the amount of \$_____ .

TOTAL ENCLOSED: \$ _____

Please indicate your appropriate membership category:

- Individual
- Amateur
- Educational Organization
- Music Business
- Library
- Other _____

Please send AVS your biographical material, photographs (clearly labeled), brochures, concert programs, posters, press releases, clippings, and other related material on a regular basis. Such items will become part of our important resource files and may be considered for publication. We serve as a clearing house for many viola-related requests.

Name _____

Telephone _____

Address _____

City / State / Zip _____

- check if this is a new address

If you are a student, in which school are you enrolled? _____

(Please list permanent address above rather than school address.)

*Send this form with check to: Donna Lively Clark, AVS Secretary,
JCFA Butler University, 4600 Sunset Ave., Indianapolis, IN 46208*

INDEX TO ADVERTISERS

Bartók Records	62	Anthony Lane	34
Bearden Violin Shop	36	Latham Music Enterprises	74
Biddulph Recordings	6	William Harris Lee, Co	56
Brigham Young University	25	Manhattan School of Music	64
Butler University	75	Steve McCann	45
Cala Records	12	Miller & Fein	70
California Summer Music	24	William Moennig & Son, Ltd	26
Clarion	20	Moes & Moes	32
Classics Unlimited	66	Music City Strings	25
John M. Connolly & Co., Inc	57	Ernest Nussbaum	00
Joseph Conrad	23	Geoffrey Ovington Violins	30
Curtin & Alf	54	RBP Music Publishers	34
D'Addario	53	Resort Publications	41
Dampit	35	Terenzio Riegel	73
Alan de Veritch	10	Dr. Maurice W. Riley	68
Lawrence Furse Violins	40	Robertson & Sons	38
Clair Givens Violins	43	San Francisco Conservatory	72
Todd Goldenberg, Violin Maker	53	William Robert Scott	52
Heritage Insurance Services, Inc	32	Shar Products Company	14
Mark Anton Hollinger	58	Southwest Strings	46
Byron Hoyt Sheet Music Service	68	Kenneth Stein Violins	17
Carleen Hutchins	37	Super-Sensitive Musical String Co	28
John-Brasil	32	Viola World Publications	8
Lee Jon Associates	58	Philip H. Weinkrantz	68
Samuel Kolstein & Son Ltd	22	Peter Zaret	8
Ira B. Kraemer & Co	34		

